

Test Report

Report No.: MTi19061215-1B012-2E

Date of issue: June 26, 2019

Sample Description: Bamboo Wireless earbuds

Model(s): P329.109

Applicant:

Address:

Date of Test: June 14, 2019 – June 26, 2019

Shenzhen Microtest Co., Ltd.
<http://www.mtitest.com>



Table of Contents

1	General description	5
1.1	Feature of equipment under test (EUT)	5
1.2	Test mode	5
1.3	Test conditions	6
1.4	Ancillary equipment list	6
1.5	Measurement Uncertainty	7
2	Testing site	7
3	List of test equipment	8
4	EMC emission test	9
4.1	Conducted emission	9
4.2	Radiated emission	12
4.3	Harmonic current emission / Voltage fluctuations & flicker	18
5	Immunity test	19
5.1	Electrostatic discharge immunity (ESD)	19
5.2	RF electromagnetic field immunity (RS)	24
5.3	Fast transients immunity (EFT)	26
5.4	Surges immunity	28
5.5	Injected current immunity (CS)	30
5.6	Voltage interruptions voltage Dips	32
	Photographs of the Test Setup	34
	Photographs of the Test EUT	39

Test Result Certification	
Applicant's name:	
Address:	
Manufacture's name:	
Address:	
Product name:	Bamboo Wireless earbuds
Trademark:	N/A
Model name:	P329.109
Series model:	N/A
Difference in series models:	N/A
Standards:	(Draft) EN 301 489-1 V2.2.1 (2019-03) (Draft) EN 301 489-17 V3.2.0 (2017-03)

This device described above has been tested by Shenzhen Microtest Co., Ltd. and the test results show that the equipment under test (EUT) is in compliance with the Radio equipment directive requirements. And it is applicable only to the tested sample identified in the report.

Tested by:



Demi Mu

June 26, 2019

Reviewed by:



Blue Zheng

June 26, 2019

Approved by:



Smith Chen

June 26, 2019

Summary of Test Result

Item	Description of Test	Result
EMC emission		
1	Conducted emission	Pass
2	Radiated emission	Pass
3	Harmonic current emission	N/A*
4	Voltage fluctuations & flicker	Pass
Immunity		
1	Electrostatic discharge immunity (ESD)	Pass
2	Radiated electromagnetic field immunity(RS)	Pass
3	Fast transients / burst immunity (EFT)	Pass
4	Surge immunity	Pass
5	Conducted disturbance immunity (CS)	Pass
6	Voltage interruptions & voltage Dips immunity	Pass

*Not Applicable.

1 General description

1.1 Feature of equipment under test (EUT)

Product name:	Bamboo Wireless earbuds
Model name:	P329.109
Power source:	DC 5V from adapter AC 230V/50Hz or DC 3.7V from battery
Antenna designation:	PCB antenna (Antenna Gain: 0.68dBi)
Battery:	DC 3.7V 55mAh
Specification:	N/A
BT	
Bluetooth version:	V5.0
Tx/Rx frequency range:	Tx/Rx: 2402MHz~2480MHz

1.2 Test mode

To investigate the maximum EMI emission characteristics generates from EUT, the test system was pre-scanning tested base on the consideration of following EUT operation mode or test configuration mode which possible have effect on EMI emission level. Each of these EUT operation mode(s) or test configuration mode(s) mentioned above was evaluated respectively.

Pretest Mode	Description
Mode 1	Charging
Mode 2	BT

For Conducted Test	
Final Test Mode	Description
Mode 1	Charging

For Radiated Test	
Final Test Mode	Description
Mode 1	Charging

For EMS Test	
Pretest Mode	Description
Mode 1	Charging

NOTE: The test modes were carried out for all operation modes. The final test mode of the EUT was the worst test mode for EMI, and its test data was showed.

1.3 Test conditions

During the measurement the environmental conditions were within the listed ranges:

- Temperature: 15°C~35°C
- Humidity: 20%~75% (30%~60% for ESD test)
- Atmospheric pressure: 98kPa~101kPa

1.4 Ancillary equipment list

Equipment	Model	S/N	Manufacturer
Adapter	/	/	/

1.5 Measurement Uncertainty

Measurement Uncertainty for a Level of Confidence of 95 %, $U=2xUc(y)$

Conducted emission(150kHz~30MHz)	± 2.5 dB
Radiated emission(30MHz~1GHz)	± 4.2 dB
Radiated emission (above 1GHz)	± 4.3 dB
Temperature	±1 degree
Humidity	± 5 %

2 Testing site

Test laboratory:	Shenzhen Microtest Co., Ltd.
Laboratory location:	No.102A & 302A, East Block, Hengfang Industrial Park, Xingye Road, Xixiang, Bao'an District, Shenzhen, Guangdong, China
CNAS Registration No.:	L5868
Telephone:	(86-755)88850135
Fax:	(86-755)88850136

Note: The item of radiated electromagnetic field immunity was tested by:

Test Site	WALTEK SERVICES (SHEN ZHEN) CO., LTD.
Test Site Location:	1/F,Fukangtai Building,West Baima Rd., Songgang Street,Baoan District, ShenZhen 518105, Guangdong,China.
Telephone:	(86-755)83551033
Fax:	(86-755)83552400
CNAS Registration No.:	L3110

3 List of test equipment

Emission test:

Equipment	Manufacturer	Model	Serial No.	Calibration Due
LISN(MTI-E037)	Schwarzbeck	NSLK8127	#841	2019/09/25
LISN(MTI-E058)	Schwarzbeck	NSLK8127	#841	2019/12/04
EMI Test Receiver	Rohde&schwarz	ESCI3	101368	2019/11/04
Broadband TRILOG Antenna	Schwarabeck	VULB9163	9163-872	2019/11/14
Horn Antenna	Schwarzbeck	BBHA 9120 D	9120D-1145	2019/11/14
Amplifier	HP	8447D	3113A06150	2019/11/04
Amplifier	Agilent	8449B	3008A02400	2019/07/04
Test Receiver	Schwarabeck	ESPI7	100314	2019/11/04
Spectrum analyzer	Agilent	E4407B	MY41441082	2019/11/04
Harmonics, Flicker & Power Analyser	Laplace	AC 2000A	311216	2019/11/04

Immunity test:

For ESD

Equipment	Manufacturer	Model	Serial No.	Calibration Due
ESD Generator	Schloder	SESD 3000	509325	2019/11/14

RS equipment

Equipment	Manufacturer	Model	Serial No.	Calibration Due
Signal Generator	R&S	SMB100A	106148	2019/09/10
RF Power Amplifier	BONN Elektronik	STLP9128D	128740	2019/09/10
Gestockte Breitband (S tacked) Log.-per.Antenna	SCHWARZBECK	STLP9128D	043	2019/09/10
Power Meter	R&S	NRP2	102031	2019/09/10
Amplifier	NJNT	NTWPAS-2560 025	2560025	2020/04/14
Broad-band Horn Antenna	SCHWARZBECK	BBHA9120D	BBHA9120D-667	2020/04/06

Note: The calibration interval of the above test instruments is 12 months and the calibrations are traceable to international system unit (SI).

4 EMC emission test

4.1 Conducted emission

4.1.1 Limits

Frequency (MHz)	Class A (dB μ V)		Class B (dB μ V)	
	Quasi-peak	Average	Quasi-peak	Average
0.15 -0.5	79	66	66 - 56 *	56 - 46 *
0.5 -5	73	60	56	46
5 -30	73	60	60	50

4.1.2 Test Procedures

The EUT was placed 0.8 meters from the horizontal ground plane with EUT being connected to the power mains through an Artificial mains networks (AMN). All other support equipment powered from additional AMN. The LISN provide 50 Ohm/ 50uH of coupling impedance for the measuring instrument.

Interconnecting cables that hang closer than 40 cm to the ground plane shall be folded back and forth in the center forming a bundle 30 to 40 cm long.

I/O cables that are not connected to a peripheral shall be bundled in the center. The end of the cable may be terminated, if required, using the correct terminating impedance. The overall length shall not exceed 1 m.

AMN is at least 80 cm from nearest part of EUT chassis.

Setup of the receiver

Frequency	Detector	Setting
0.15MHz – 30MHz	QP	IF bandwidth: 9kHz

4.1.3 Test setup

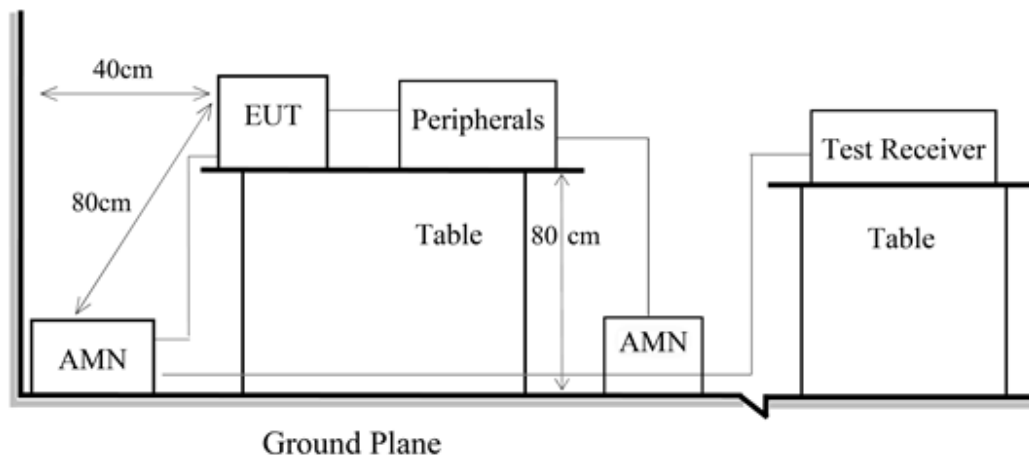

4.1.4 Test Result

EUT:	Bamboo Wireless earbuds	Model Name:	P329.109
Pressure:	101kPa	Phase:	L
Test voltage:	DC 5V from Adapter AC 230V/50Hz	Test mode:	Mode 1

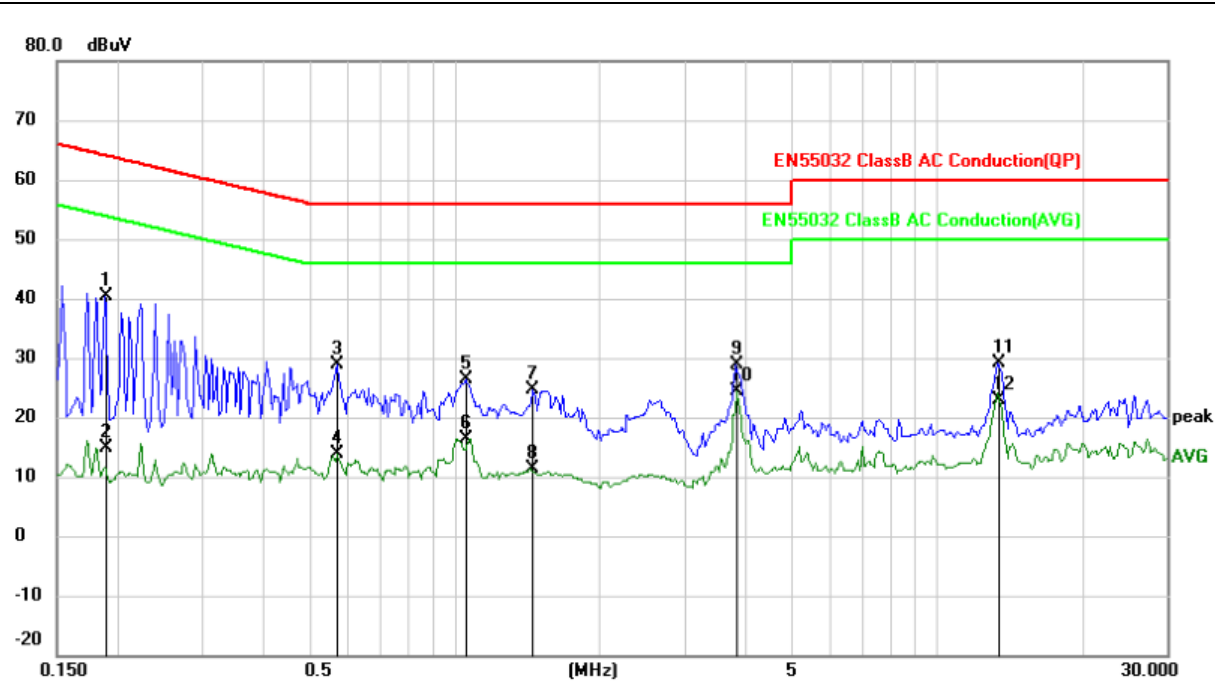

No.	Mk.	Freq. MHz	Reading Level dBuV	Correct Factor dB	Measure- ment dBuV	Limit dBuV	Over dB	Detector	Comment
1		0.1891	30.72	9.73	40.45	64.08	-23.63	QP	
2		0.1891	5.16	9.73	14.89	54.08	-39.19	AVG	
3		0.5719	18.88	9.89	28.77	56.00	-27.23	QP	
4		0.5719	3.87	9.89	13.76	46.00	-32.24	AVG	
5		1.0562	16.33	9.95	26.28	56.00	-29.72	QP	
6		1.0562	6.47	9.95	16.42	46.00	-29.58	AVG	
7		1.4547	14.71	9.96	24.67	56.00	-31.33	QP	
8		1.4547	1.53	9.96	11.49	46.00	-34.51	AVG	
9		3.8242	18.96	10.02	28.98	56.00	-27.02	QP	
10	*	3.8242	14.26	10.02	24.28	46.00	-21.72	AVG	
11		13.3672	18.79	10.22	29.01	60.00	-30.99	QP	
12		13.3672	12.57	10.22	22.79	50.00	-27.21	AVG	

EUT:	Bamboo Wireless earbuds	Model Name:	P329.109
Pressure:	101kPa	Phase:	N
Test voltage:	DC 5V from Adapter AC 230V/50Hz	Test mode:	Mode 1

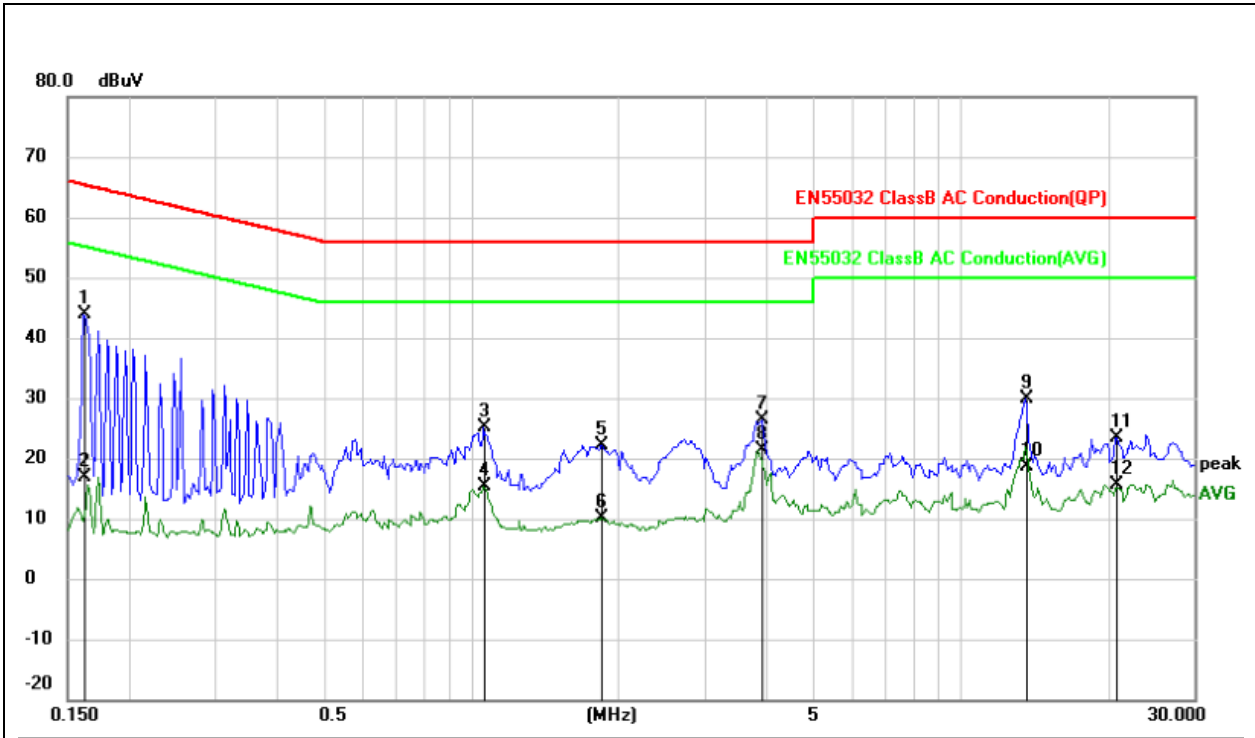

No.	Mk.	Freq. MHz	Reading Level dBuV	Correct Factor dB	Measure- ment dBuV	Limit dBuV	Over dB	Detector	Comment
1	*	0.1617	34.25	9.73	43.98	65.38	-21.40	QP	
2		0.1617	7.06	9.73	16.79	55.38	-38.59	AVG	
3		1.0602	15.07	9.95	25.02	56.00	-30.98	QP	
4		1.0602	5.49	9.95	15.44	46.00	-30.56	AVG	
5		1.8414	12.28	9.97	22.25	56.00	-33.75	QP	
6		1.8414	0.08	9.97	10.05	46.00	-35.95	AVG	
7		3.9258	16.30	10.03	26.33	56.00	-29.67	QP	
8		3.9258	11.40	10.03	21.43	46.00	-24.57	AVG	
9		13.5938	19.54	10.22	29.76	60.00	-30.24	QP	
10		13.5938	8.47	10.22	18.69	50.00	-31.31	AVG	
11		20.8008	13.23	10.12	23.35	60.00	-36.65	QP	
12		20.8008	5.53	10.12	15.65	50.00	-34.35	AVG	

4.2 Radiated emission

4.2.1 Limits

Frequency (MHz)	Class B Limit (dB μ V/m)		Class A Limit (dB μ V/m)	
	Quasi-peak/Peak	Average	Quasi-peak/Peak	Average
30 ~ 230	40 (at 3m)	/	50 (at 3m)	/
230 ~ 1000	47 (at 3m)	/	57 (at 3m)	/
1000 ~ 3000	70 (at 3m)	50 (at 3m)	76 (at 3m)	56 (at 3m)
3000 ~ 6000	74 (at 3m)	54 (at 3m)	80 (at 3m)	60 (at 3m)

4.2.2 Test Procedures

- The measuring distance of at 3 m shall be used for measurements at frequency up to 1GHz. For frequencies above 1GHz, any suitable measuring distance may be used.
- The EUT was placed on the top of a rotating table 0.8 meters above the ground at a 10 meter open area test site. The table was rotated 360 degrees to determine the position of the highest radiation.
- The height of the equipment or of the substitution antenna shall be 0.8 m; the height of the test antenna shall vary between 1 m to 4 m. Both horizontal and vertical polarizations of the antenna are set to make the measurement.
- The initial step in collecting conducted emission data is a spectrum analyzer peak detector mode pre-scanning the measurement frequency range. Significant peaks are then marked and then Quasi Peak detector mode re-measured.
- If the Peak Mode measured value compliance with and lower than Quasi Peak Mode Limit, the EUT shall be deemed to meet QP Limits and then no additional QP Mode measurement performed.
- For the actual test configuration, please refer to the related item –EUT Test Photos.

Setup of receiver

Frequency	Detector	Setting
30MHz – 1GHz	QP	IF bandwidth: 120kHz
Above 1GHz	Peak	RBW: 1MHz, VBW: 3MHz
	AV	RBW: 1MHz, VBW: 10Hz

4.2.3 Test Setup

Radiated Emission Test Set-Up Frequency Below 1 GHz

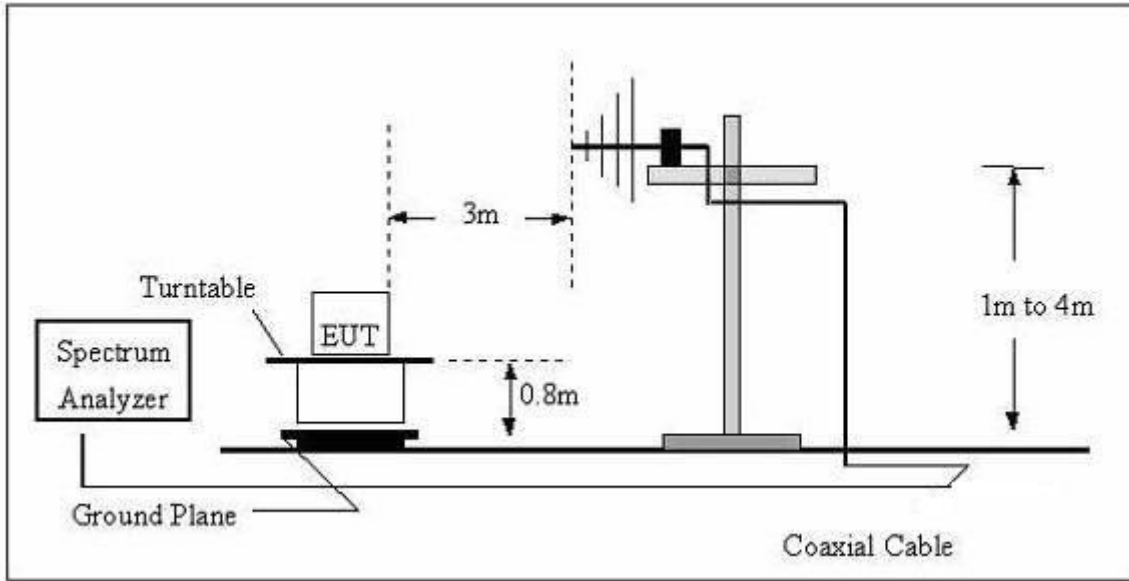

Radiated Emission Test Set-Up Frequency Above 1GHz

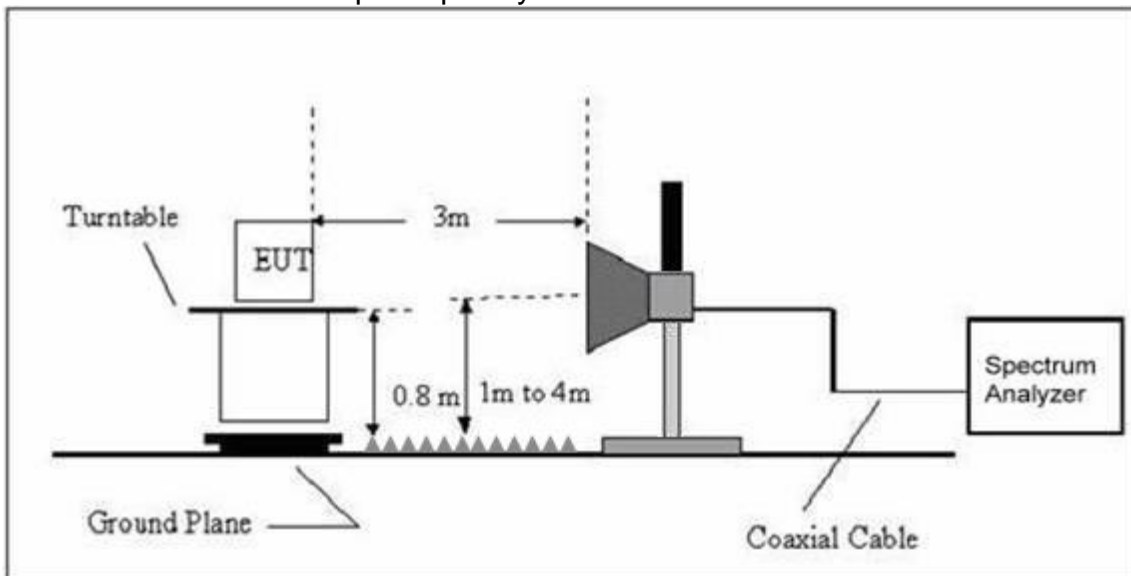

4.2.4 Test Result

EUT:	Bamboo Wireless earbuds	Model Name:	P329.109
Pressure:	101kPa	Polarization:	Horizontal
Test voltage:	DC 5V from Adapter AC 230V/50Hz	Test mode:	Mode 1

30MHz-1GHz

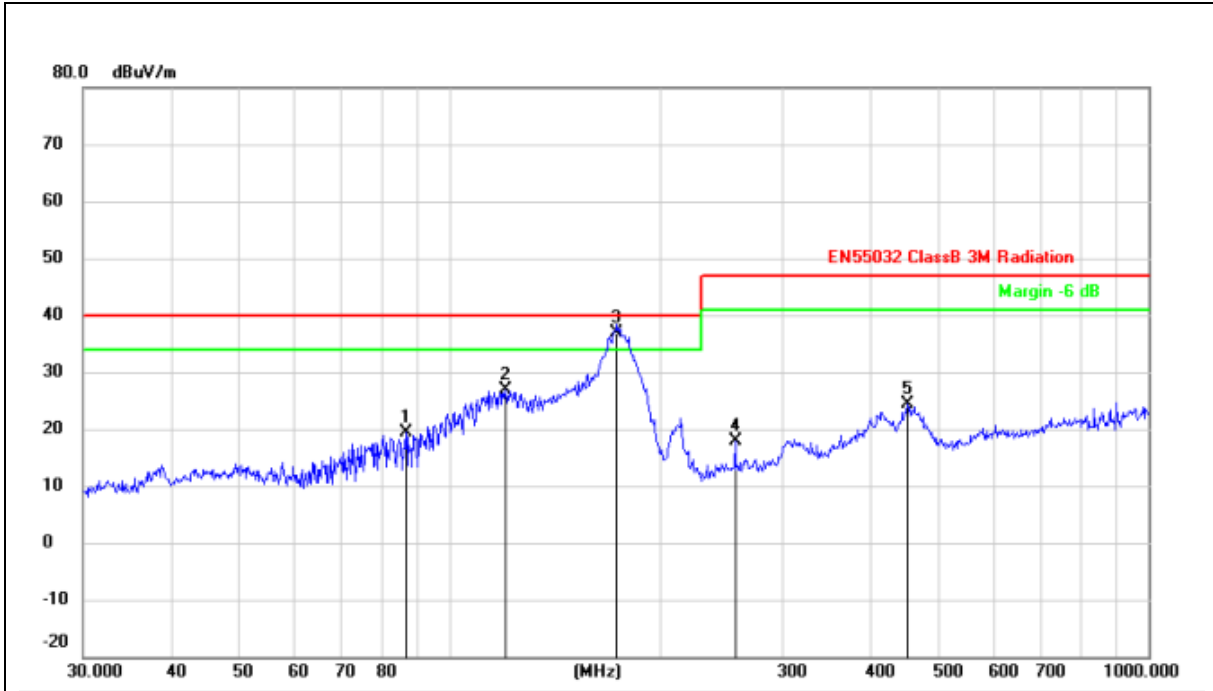

No.	Mk.	Freq. MHz	Reading Level dBuV	Correct Factor dBuV/m	Measure- ment dBuV/m	Limit dBuV/m	Over dB	Detector
1		86.8067	35.76	-16.45	19.31	40.00	-20.69	QP
2		120.6991	41.72	-14.76	26.96	40.00	-13.04	QP
3	*	173.8135	52.35	-15.35	37.00	40.00	-3.00	QP
4		256.5210	29.59	-11.75	17.84	47.00	-29.16	QP
5		452.7197	33.47	-9.10	24.37	47.00	-22.63	QP

EUT:	Bamboo Wireless earbuds	Model Name:	P329.109
Pressure:	101kPa	Polarization:	Vertical
Test voltage:	DC 5V from Adapter AC 230V/50Hz	Test mode:	Mode 1

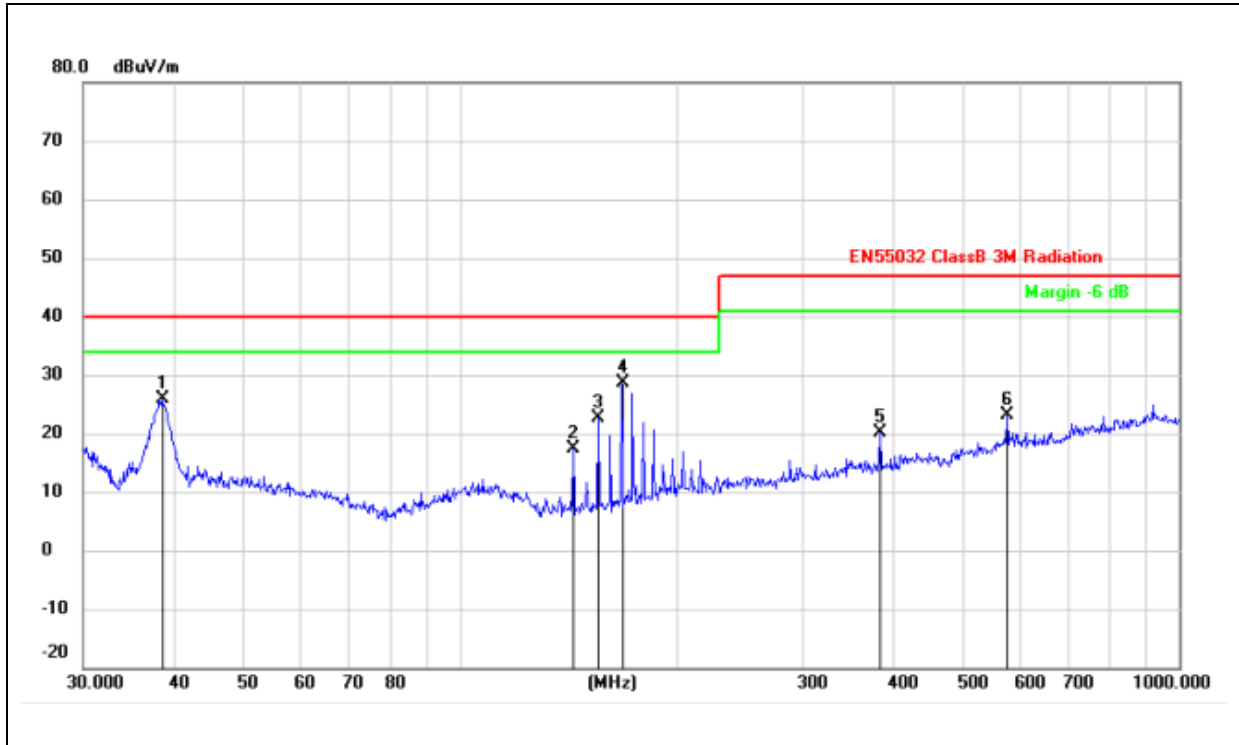

No.	Mk.	Freq. MHz	Reading Level dBuV	Correct Factor dBuV/m	Measure- ment dBuV/m	Limit dBuV/m	Over dB	Detector
1		38.6160	39.73	-13.79	25.94	40.00	-14.06	QP
2		143.8295	34.14	-16.65	17.49	40.00	-22.51	QP
3		155.9101	38.91	-16.38	22.53	40.00	-17.47	QP
4	*	167.8243	44.26	-15.65	28.61	40.00	-11.39	QP
5		383.9318	30.07	-9.92	20.15	47.00	-26.85	QP
6		576.6443	29.48	-6.40	23.08	47.00	-23.92	QP

EUT:	Bamboo Wireless earbuds	Model Name:	P329.109
Pressure:	101kPa	Polarization:	Horizontal
Test voltage:	DC 5V from Adapter AC 230V/50Hz	Test mode:	Mode 1

1GHz-6GHz

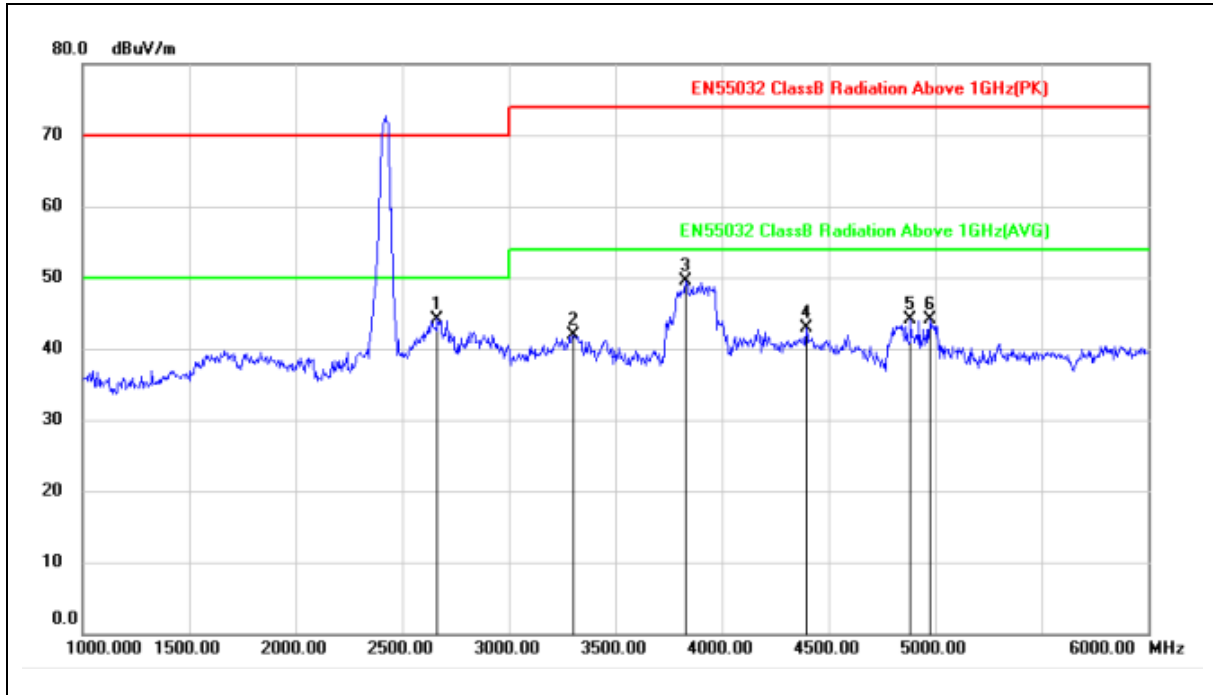

No.	Mk.	Freq. MHz	Reading Level dBuV	Correct Factor dBuV/m	Measure- ment dBuV/m	Limit dBuV/m	Over dB	Detector
1		2665.000	51.49	-7.29	44.20	70.00	-25.80	peak
2		3300.000	46.53	-4.69	41.84	74.00	-32.16	peak
3	*	3830.000	52.85	-3.30	49.55	74.00	-24.45	peak
4		4395.000	47.78	-4.85	42.93	74.00	-31.07	peak
5		4885.000	51.65	-7.63	44.02	74.00	-29.98	peak
6		4975.000	52.15	-8.14	44.01	74.00	-29.99	peak

Note 1: The test modes were carried out for all operation modes. The worst test mode for test data was showed in the report.

2: Exceeding the emission limit is the main frequency.

3: Peak test margin is greater than 20dBm, so AVG is also pass.

EUT:	Bamboo Wireless earbuds	Model Name:	P329.109
Pressure:	101kPa	Polarization:	Vertical
Test voltage:	DC 5V from Adapter AC 230V/50Hz	Test mode:	Mode 1

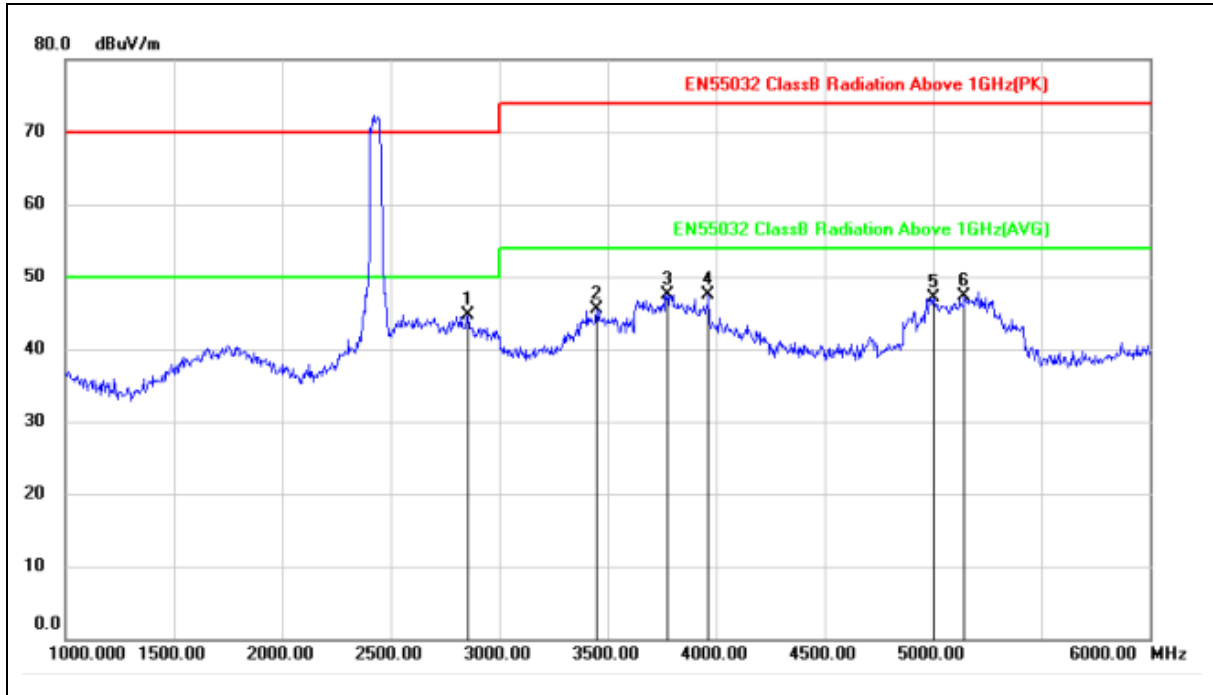

No.	Mk.	Freq. MHz	Reading Level dBuV	Correct Factor dBuV/m	Measure- ment dBuV/m	Limit dBuV/m	Over dB	Detector
1	*	2855.000	52.16	-7.54	44.62	70.00	-25.38	peak
2		3450.000	51.53	-6.08	45.45	74.00	-28.55	peak
3		3775.000	52.59	-5.03	47.56	74.00	-26.44	peak
4		3965.000	51.87	-4.34	47.53	74.00	-26.47	peak
5		5005.000	57.12	-9.98	47.14	74.00	-26.86	peak
6		5145.000	56.93	-9.72	47.21	74.00	-26.79	peak

- Note 1: The test modes were carried out for all operation modes. The worst test mode for test data was showed in the report.
 2: Exceeding the emission limit is the main frequency.
 3: Peak test margin is greater than 20dBm, so AVG is also pass.

4.3 Harmonic current emission / Voltage fluctuations & flicker

4.3.1 Test Procedures

The EUT was installed and placed on a non-conductive table and operated to produce the maximum harmonic components under normal operating conditions for each successive harmonic component in turn.

The correspondent test program of test instrument to measure the current harmonics / voltage fluctuations & flicker emanated from EUT. The measure time shall be not less than the time necessary for the EUT to be exercised.

4.3.2 Test Setup

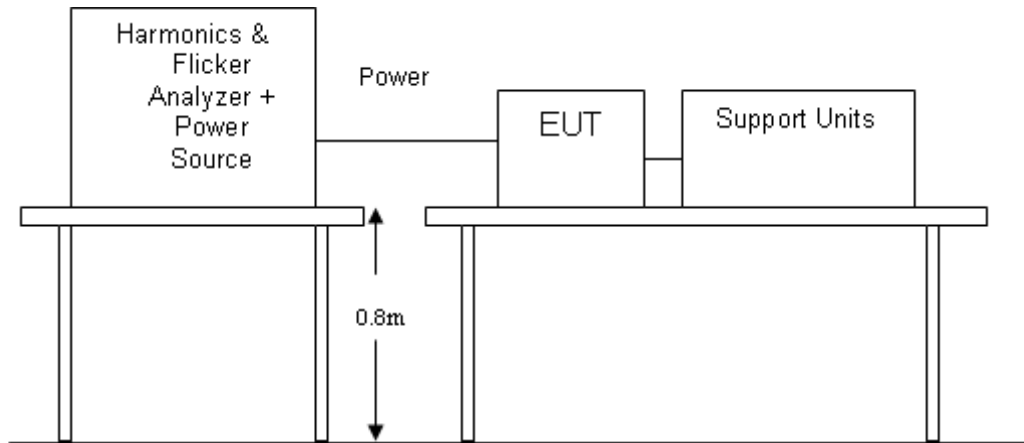

4.3.3 Test Result

Harmonic current emission:

N/A, the rated power of EUT is below 75W.

Voltage fluctuations & flicker:

EUT:	Bamboo Wireless earbuds	Model Name:	P329.109
Pressure:	101kPa	Test mode:	Mode 1

	Pst	dc (%)	dmax (%)	d(t) > 3.3% (ms)
Limit	1.000	3.300	4.000	500
Reading	0.12	0.38	0.81	0

5 Immunity test

5.1 Electrostatic discharge immunity (ESD)

5.1.1 Test Method

The test method shall be in accordance with EN 61000-4-2.

For radio equipment and ancillary equipment the following requirements and evaluation of test results shall apply.

The test severity level for contact discharge shall be 4 kV and for air discharge 8kV. All other details, including intermediate test levels, are contained within EN 61000-4-2.

Electrostatic discharges shall be applied to all exposed surfaces of the EUT except where the user documentation specifically indicates a requirement for appropriate protective measures (see EN 61000-4-2).

5.1.2 Performance criteria

According to **EN 301489-17** standard, the general performance criteria as following:

Criteria	During the test	After the test
A	<p>Shall operate as intended. (see note 1). Shall be no loss of function. Shall be no unintentional transmissions</p>	<p>Shall operate as intended. Shall be no degradation of performance (see note 3). Shall be no loss of function. Shall be no loss of stored data or user programmable functions</p>
B	<p>May show loss of function (one or more). May show degradation of performance (see note 2). Shall be no unintentional transmissions.</p>	<p>Functions shall be self-recoverable. Shall operate as intended after recovering. Shall be no degradation of performance (see note 3). Shall be no loss of stored data or user programmable functions.</p>
C	<p>May be loss of function (one or more)</p>	<p>Functions shall be recoverable by the operator. Shall operate as intended after recovering. Shall be no degradation of performance (see note 3).</p>

NOTE 1: Operate as intended during the test allows a level of degradation not below a minimum performance level specified by the manufacturer for the use of the apparatus as intended. In some cases the specified minimum performance level may be replaced by a permissible degradation of performance. If the minimum performance level or the permissible performance degradation is not specified by the manufacturer then either of these may be derived from the product description and documentation (including leaflets and advertising) and what the user may reasonably expect from the apparatus if used as intended.

NOTE 2: Degradation of performance during the test is understood as a degradation to a level not below a minimum performance level specified by the manufacturer for the use of the apparatus as intended. In some cases the specified minimum performance level may be replaced by a permissible degradation of performance.

If the minimum performance level or the permissible performance degradation is not specified by the manufacturer then either of these may be derived from the product description and documentation (including leaflets and advertising) and what the user may reasonably expect from the apparatus if used

as intended.

NOTE 3: No degradation of performance after the test is understood as no degradation below a minimum performance level specified by the manufacturer for the use of the apparatus as intended. In some cases the specified minimum performance level may be replaced by a permissible degradation of performance. After the test no change of actual operating data or user retrievable data is allowed. If the minimum performance level or the permissible performance degradation is not specified by the manufacturer then either of these may be derived from the product description and documentation (including leaflets and advertising) and what the user may reasonably expect from the apparatus if used as intended.

PERFORMANCE FOR TT

The performance criteria B shall apply, except for voltage dips of 100 ms and voltage interruptions of 5 000 ms duration, for which performance criteria C shall apply. Tests shall be repeated with the EUT in standby mode (if applicable) to ensure that unintentional transmission does not occur. In systems using acknowledgement signals, it is recognized that an acknowledgement (ACK) or not-acknowledgement (NACK) transmission may occur, and steps should be taken to ensure that any transmission resulting from the application of the test is correctly interpreted.

PERFORMANCE FOR TR

The performance criteria B shall apply, except for voltage dips of 100 ms and voltage interruptions of 5 000 ms duration for which performance criteria C shall apply. Where the EUT is a transceiver, under no circumstances, shall the transmitter operate unintentionally during the test. In systems using acknowledgement signals, it is recognized that an ACK or NACK transmission may occur, and steps should be taken to ensure that any transmission resulting from the application of the test is correctly interpreted.

PERFORMANCE FOR CT

The performance criteria A shall apply. Tests shall be repeated with the EUT in standby mode (if applicable) to ensure that unintentional transmission does not occur. In systems using acknowledgement signals, it is recognized that an Acknowledgement (ACK) or Not Acknowledgement (NACK) transmission may occur, and steps should be taken to ensure that any transmission resulting from the application of the test is correctly interpreted.

PERFORMANCE FOR CR

The performance criteria A shall apply. Where the EUT is a transceiver, under no circumstances, shall the transmitter operate unintentionally during the test. In systems using acknowledgement signals, it is recognized that an ACK or NACK transmission may occur, and steps should be taken to ensure that any transmission resulting from the application of the test is correctly interpreted.

5.1.3 Test Setup

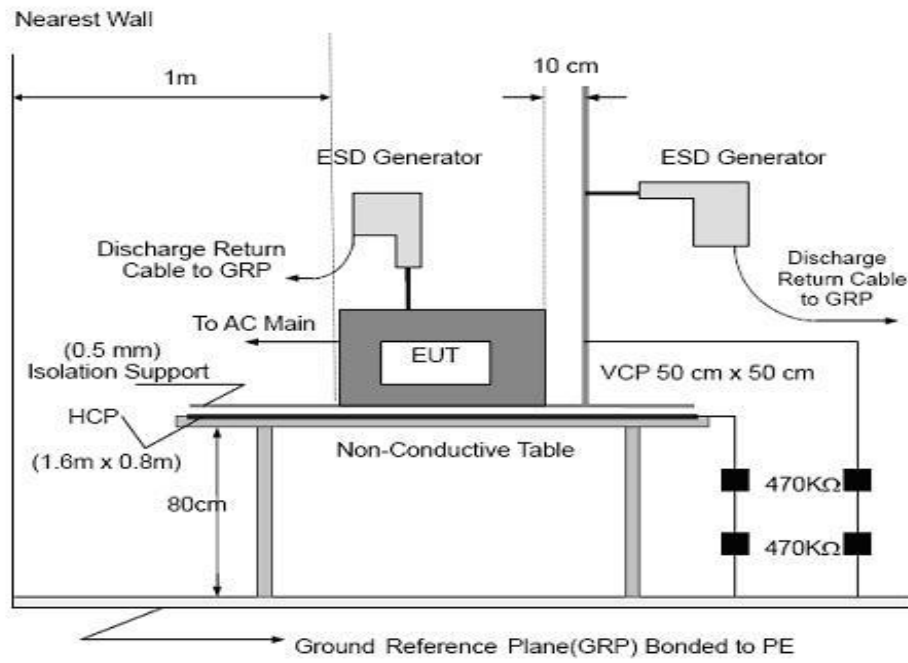

5.1.4 Test Result

EUT:	Bamboo Wireless earbuds	Model Name:	P329.109
Pressure:	101kPa	Test mode:	Mode 1

Indirect discharge

Test Point	Contact discharge level (kV)	Number and polarity	Criterion met	Criterion Required
1. VCP-Front side	<input type="checkbox"/> ..2 <input checked="" type="checkbox"/> ..4	10 (+)	A	B
	<input type="checkbox"/> ..6 <input type="checkbox"/> ..8	10 (-)	A	
2.VCP-Rear side	<input type="checkbox"/> ..2 <input checked="" type="checkbox"/> ..4	10 (+)	A	
	<input type="checkbox"/> ..6 <input type="checkbox"/> ..8	10 (-)	A	
3.VCP-Left side	<input type="checkbox"/> ..2 <input checked="" type="checkbox"/> ..4	10 (+)	A	
	<input type="checkbox"/> ..6 <input type="checkbox"/> ..8	10 (-)	A	
4. VCP-Right side	<input type="checkbox"/> ..2 <input checked="" type="checkbox"/> ..4	10 (+)	A	
	<input type="checkbox"/> ..6 <input type="checkbox"/> ..8	10 (-)	A	
5. HCP	<input type="checkbox"/> ..2 <input checked="" type="checkbox"/> ..4	10 (+)	A	
	<input type="checkbox"/> ..6 <input type="checkbox"/> ..8	10 (-)	A	

Result: Compliance.

Direct discharge

Test Point	Contact discharge level (kV)	Air discharge level (kV)	Number and polarity	Criterion met	Criterion Required
1. Each nonconductive location touchable by hand	<input type="checkbox"/> ..2 <input type="checkbox"/> ..4	<input type="checkbox"/> ..2 <input type="checkbox"/> ..4	10 (+)	A	B
	<input type="checkbox"/> ..6 <input type="checkbox"/> ..8	<input type="checkbox"/> ..6 <input checked="" type="checkbox"/> ..8	10 (-)	A	
1. Each conductive location touchable by hand	<input type="checkbox"/> ..2 <input checked="" type="checkbox"/> ..4	<input type="checkbox"/> ..2 <input type="checkbox"/> ..4	10 (+)	A	
	<input type="checkbox"/> ..6 <input type="checkbox"/> ..8	<input type="checkbox"/> ..6 <input type="checkbox"/> ..8	10 (-)	A	

Result: compliance.

Note1: Please see the photographs below about the details of test points.

THIS DOCUMENT WAS REDACTED WITH THE PRODUCTIP REDACTION TOOL ON 2019-07-05. AT THE TIME OF GENERATING THE DOCUMENT THE ORIGINAL DOCUMENT WAS AVAILABLE ALSO. THE ORIGINAL CAN ONLY BE MADE AVAILABLE BY THE DOCUMENT OWNER.

Test location

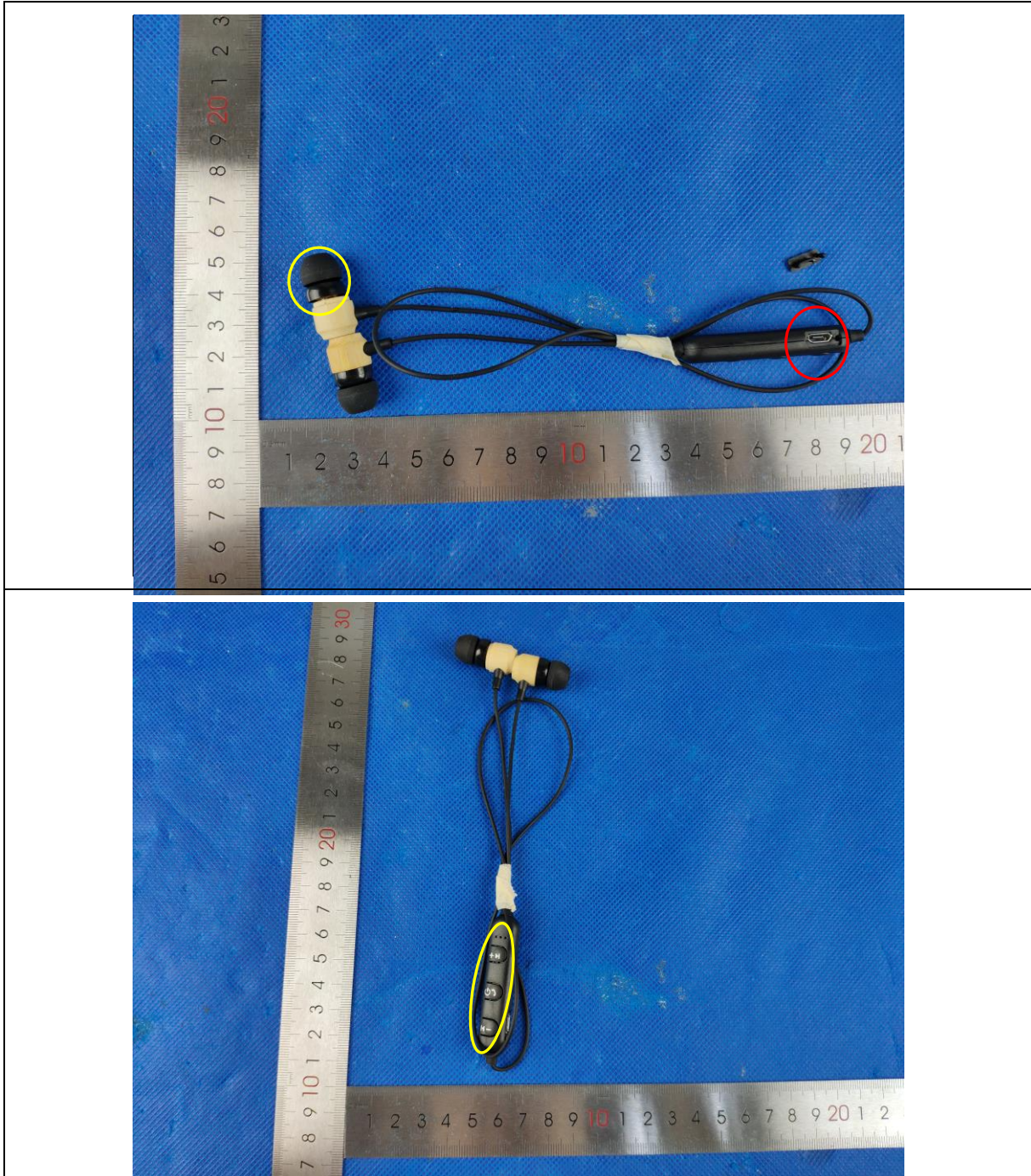

Note: Yellow circle for Air Discharge, Red circle for Contact Discharge

5.2 RF electromagnetic field immunity (RS)

5.2.1 Test Method

The test method shall be in accordance with EN 61000-4-3.

The following requirements and evaluation of test results shall apply:

- the test level shall be 3V/m (measured unmodulated). The test signal shall be amplitude modulated to a depth of 80% by a sinusoidal audio signal of 1000Hz. If the wanted signal is modulated at 1000Hz, then an audio signal of 400Hz shall be used;
- the test shall be performed over the frequency range 80 MHz to 6 000 MHz with the exception of the exclusion band for transmitters, receivers and duplex transceivers, as appropriate;
- for receivers and transmitters the stepped frequency increments shall be 1 % frequency increment of the momentary used frequency,.
- the dwell time of the test phenomena at each frequency shall not be less than the time necessary for the EUT to be exercised and to be able to respond.

5.2.2 Performance criteria

For transmitters the performance criteria for continuous phenomena for transmitters shall apply.

For receivers the performance criteria for continuous phenomena for receivers shall apply.

For ancillary equipment the pass/failure criteria supplied by the manufacturer shall apply, unless the ancillary equipment is tested in connection with a receiver or transmitter in which case the corresponding performance criteria above shall apply.

5.2.3 Test setup

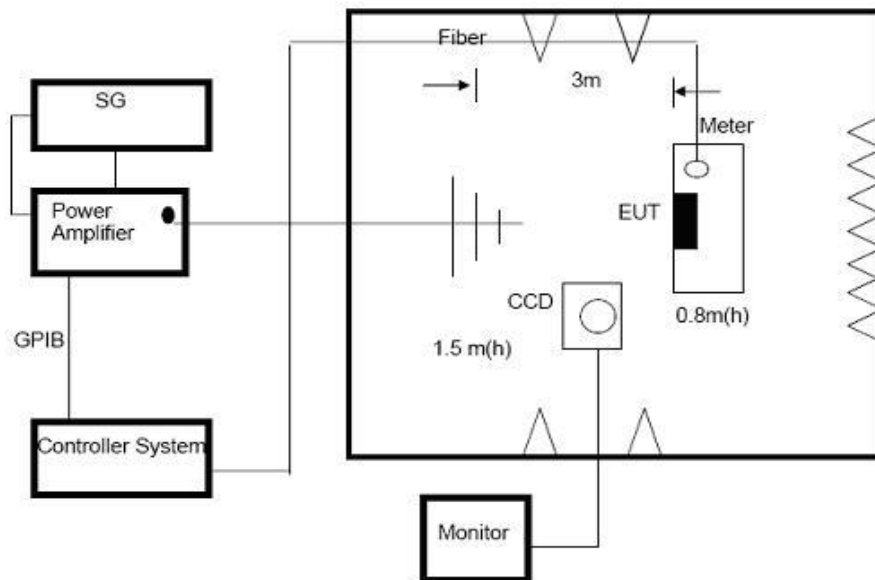

5.2.4 Test Result

EUT:	Bamboo Wireless earbuds	Model Name:	P329.109
Pressure:	101kPa	Test mode:	Mode 1

Frequency Range (MHz)	RF Field Position	R.F. Field Strength	Azimuth	Criterion met	Criterion Required
80~6000	H / V	3 V/m (rms) AM Modulated 1000Hz, 80%	Front	A	A
			Rear		
			Left		
			Right		

Result: compliance.

Note:

1. The exclusion band has not been tested in 80MHz~6GHz.

The exclusion band for immunity testing of equipment operating in the 2,4 GHz band shall be: •

lower limit of exclusion band = lowest allocated band edge frequency -120 MHz, i.e. 2 280 MHz; •

upper limit of exclusion band = highest allocated band edge frequency +120 MHz, i.e. 2 603,5MHz.

2. "A" stand for, during test, operate as intended no loss of function, no degradation of performance, no unintentional transmissions and after test, no degradation of performance,
no loss of function, no loss of stored data or user programmable functions.

5.3 Fast transients immunity (EFT)

5.3.1 Test Procedures

The test method shall be in accordance with EN 61000-4-4.

The following requirements and evaluation of test results shall apply:

- the test level for signal ports, telecommunication ports, and control ports shall be 0.5kV open circuit voltage at a repetition rate of 5kHz as given in EN 61000-4-4;
- the test level for DC power input ports shall be 0.5kV open circuit voltage as given EN 61000-4-4;
- the test level for AC mains power input ports shall be 1kV open circuit voltage as given EN 61000-4-4.

5.3.2 Performance criteria

For transmitters the performance criteria for transient phenomena for transmitter shall apply.

For receivers the performance criteria for transient phenomena for receivers shall apply.

For ancillary equipment the pass/failure criteria supplied by the manufacturer shall apply, unless the ancillary equipment is tested in connection with a receiver or transmitter in which case the corresponding performance criteria shall apply.

5.3.3 Test Setup

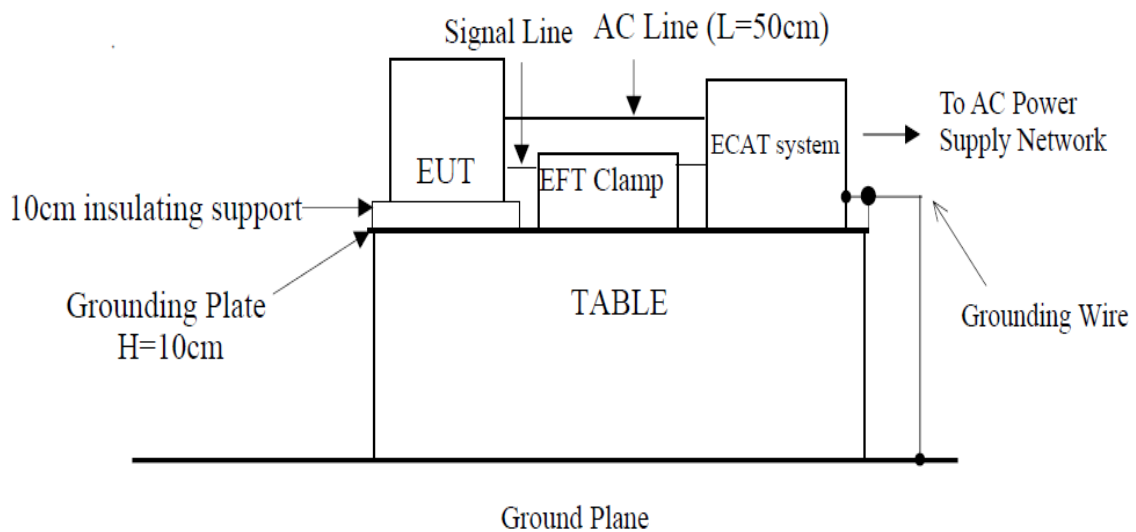

5.3.4 Test Result

EUT:	Bamboo Wireless earbuds	Model Name:	P329.109
Pressure:	101kPa	Test mode:	Mode 1

Port Type	Injected Line	Test Voltage	Criterion met	Criterion Required
AC Mains	L	±1kV	A	B
	N	±1kV	A	
	L+N	±1kV	A	

Result: compliance.

5.4 Surges immunity

5.4.1 Test Method

The test method shall be in accordance with EN 61000-4-5.

Test method for telecommunication ports directly connected to outdoor cables:

The test level for telecommunications ports, intended to be directly connected to the telecommunications network via outdoor cables, shall be 1kV line to ground as given in EN 61000-4-5, however, in telecommunications centres 0.5kV line to ground shall be used. In this case the total output impedance of the surge generator shall be in accordance with the basic standard EN 61000-4-5. The test generator shall provide the 1.2/50 μ s pulse as defined in EN 61000-4-5.

Test method for telecommunication ports connected to indoor cables:

The test level for telecommunication ports, intended to be connected to indoor cables (longer than 10m) shall be 0.5kV line to ground. In this case the total output impedance of the surge generator shall be in accordance with the basic standard EN 61000-4-5. The test generator shall provide the 1,2/50 μ s pulse as defined in EN 61000-4-5.

Test method for mains ports:

The test level for ac mains power input ports shall be 2kV line to ground, and 1kV line to line, with the output impedance of the surge generator as given in EN 61000-4-5. In telecom centres 1kV line to ground and 0,5kV line to line shall be used. The test generator shall provide the 1,2/50 μ s pulse as defined in EN 61000-4-5.

5.4.2 Performance criteria

For transmitters the performance criteria for transient phenomena for transmitters shall apply.

For receivers the performance criteria for transient phenomena for receivers shall apply.

For ancillary equipment the pass/failure criteria supplied by the manufacturer shall apply, unless the ancillary equipment is tested in connection with a receiver or transmitter in which case the corresponding performance criteria above shall apply.

5.4.3 Test Setup

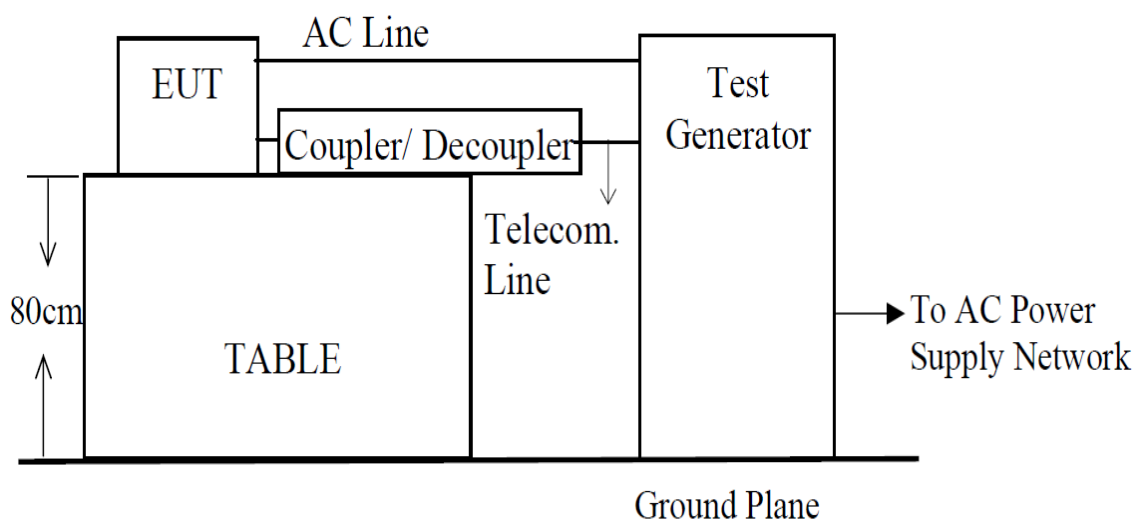

5.4.4 Test Result

EUT:	Bamboo Wireless earbuds	Model Name:	P329.109
Pressure:	101kPa	Test mode:	Mode 1

Port Type	Injected Line	Test Voltage	Criterion met	Criterion Required
AC Mains	L – N	±0.5kV, ±1kV	A	A

Result: Compliance.

THIS DOCUMENT WAS REDACTED WITH THE PRODUCTIP REDACTION TOOL ON 2019-07-05. AT THE TIME OF GENERATING THE DOCUMENT THE ORIGINAL DOCUMENT WAS AVAILABLE ONLY BE MADE AVAILABLE BY THE DOCUMENT OWNER.

5.5 Injected current immunity (CS)

5.5.1 Test Method

The test method shall be in accordance with EN 61000-4-6.

The following requirements and evaluation of test results shall apply:

- the test level shall be severity level 2 as given in EN 61000-4-6 corresponding to 3V rms unmodulated. The test signal shall then be amplitude modulated to a depth of 80% by a sinusoidal audio signal of 1000Hz. If the wanted signal is modulated at 1000Hz, then the test signal of 400Hz shall be used;
- the test shall be performed over the frequency range 150kHz to 80MHz with the exception of an exclusion band for transmitters, and for receivers and duplex transceivers;
- for receivers and transmitters the stepped frequency increments shall be 1% frequency increment of the momentary frequency in the frequency range 150kHz to 80MHz;
- the injection method to be used shall be selected according to the basic standard EN 61000-4-6;
- responses on receivers or receiver parts of transceivers occurring at discrete frequencies which are narrow band responses (spurious responses), are disregarded from the test;

5.5.2 Performance criteria

For transmitters the performance criteria for continuous phenomena for transmitter shall apply.

For receivers the performance criteria for continuous phenomena for receivers shall apply.

For ancillary equipment the pass/failure criteria supplied by the manufacturer shall apply, unless the ancillary equipment is tested in connection with receivers or transmitters in which case the corresponding performance criteria above shall apply.

5.5.3 Test Setup

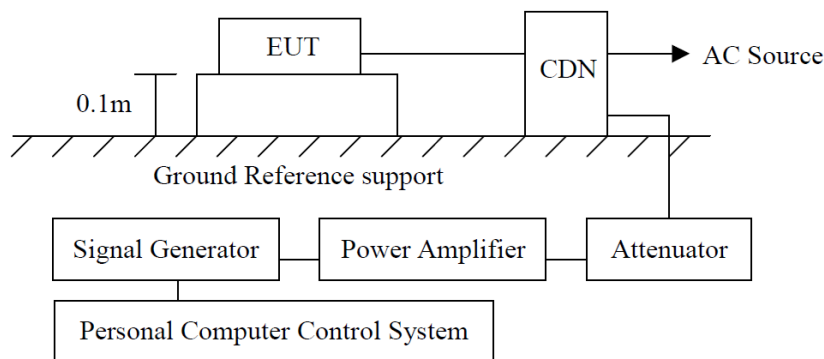

5.5.4 Test Result

EUT:	Bamboo Wireless earbuds	Model Name:	P329.109
Pressure:	101kPa	Test mode:	Mode 1

Port Type	Frequency (MHz)	Test Voltage	Criterion met	Criterion Required
AC Mains	0.15 to 80	3 V (rms) AM Modulated 1000Hz, 80%	A	A

Result: Compliance.

Note:EUT is used for this calibration, the output of the audio source was adjusted to achieve a reference Level equivalent to a SPL of -5 dB Pa at 1 kHz at the Mouth Reference Point (MRP), the reading of the audio level meter, which was connected to the output of the communication tester, was recorded as a reference level. During the test, the uplink speech output level was monitored, it was confirmed to be at least 35 dB less than the previously- recorded reference level.

THIS DOCUMENT WAS REDACTED WITH THE PRODUCTIP REDACTION TOOL ON 2019-07-05. AT THE TIME OF GENERATING THE DOCUMENT THE ORIGINAL DOCUMENT WAS AVAILABLE ALSO. THE ORIGINAL CAN ONLY BE MADE AVAILABLE BY THE DOCUMENT OWNER.

5.6 Voltage interruptions voltage Dips

5.6.1 Test Method

The test method shall be in accordance with EN 61000-4-11.

The test levels shall be:

- voltage dip: 0% residual voltage for 0.5 cycle;
- voltage dip: 0% residual voltage for 1 cycle;
- voltage dip: 70% residual voltage for 25 cycles (at 50Hz);
- voltage interruption: 0% residual voltage for 250 cycles (at 50 Hz).

5.6.2 Performance criteria

For a voltage dip the following performance criteria apply:

- for transmitters the performance criteria for transient phenomena for transmitter shall apply;
- for receivers the performance criteria for transient phenomena for receiver shall apply;
- for ancillary equipment the pass/failure criteria supplied by the manufacturer shall apply, unless the ancillary equipment is tested in connection with a receiver or transmitter in which case the corresponding performance criteria above shall apply.

For a voltage interruption the following performance criteria apply:

- in the case where the equipment is fitted with or connected to a battery back-up, the performance criteria for transient phenomena for transmitters or for receivers shall apply;
- in the case where the equipment is powered solely from the AC mains supply (without the use of a parallel battery back-up) volatile user data may have been lost and if applicable the communication link need not to be maintained and lost functions should be recoverable by user or operator;
- no unintentional responses shall occur at the end of the test; • in the event of loss of function(s) or in the event of loss of user stored data, this fact shall be recorded in the test report;
- for ancillary equipment the pass/failure criteria supplied by the manufacturer shall apply, unless the ancillary equipment is tested in connection with

5.6.3 Test Setup

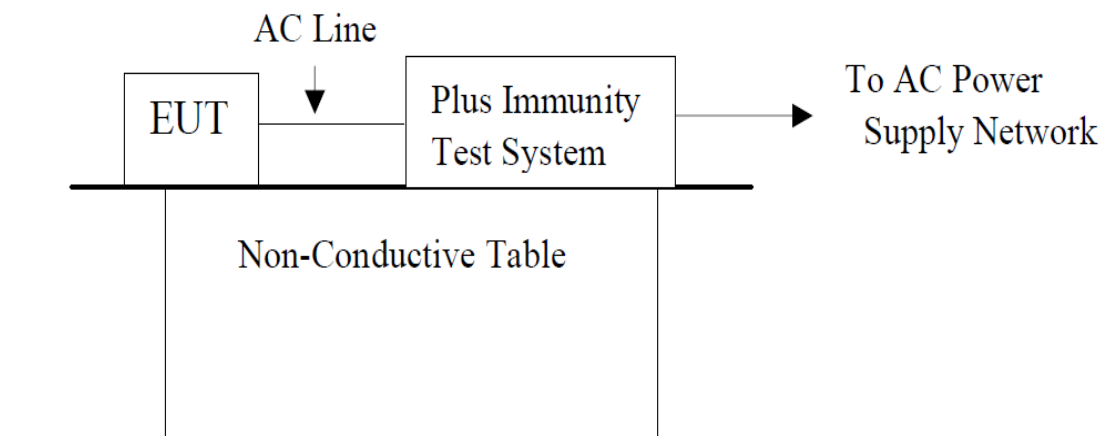

5.6.4 Test Result

EUT:	Bamboo Wireless earbuds	Model Name:	P329.109
Pressure:	101kPa	Test mode:	Mode 1

Test Level in %U _T	Duration (Period)	Criterion Required	Criterion met
0%	0.5	B	A
0%	1	B	A
70%	25	C	C
0%	250	C	C

Result: Compliance.

Photographs of the Test Setup

Radiated Emission Below 1G



Radiated Emission Above 1G



Conducted emission

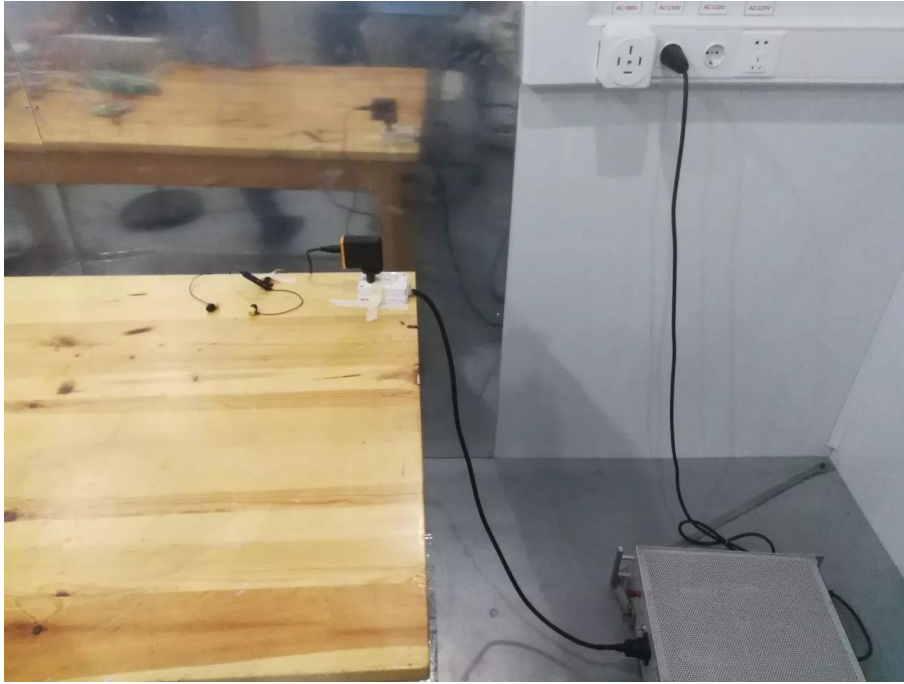

Flicker



ESD

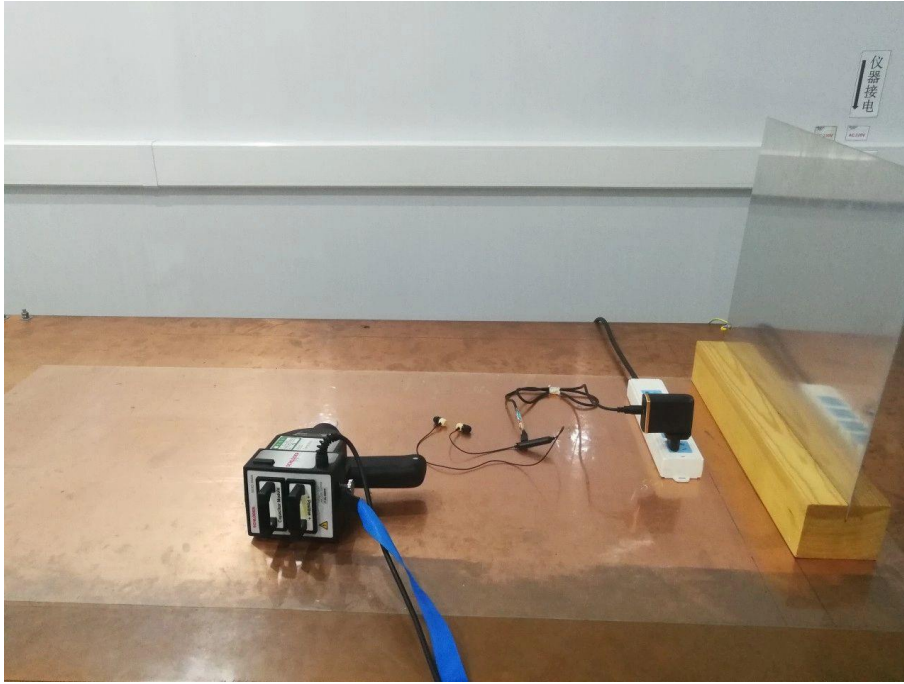

RS



EFT

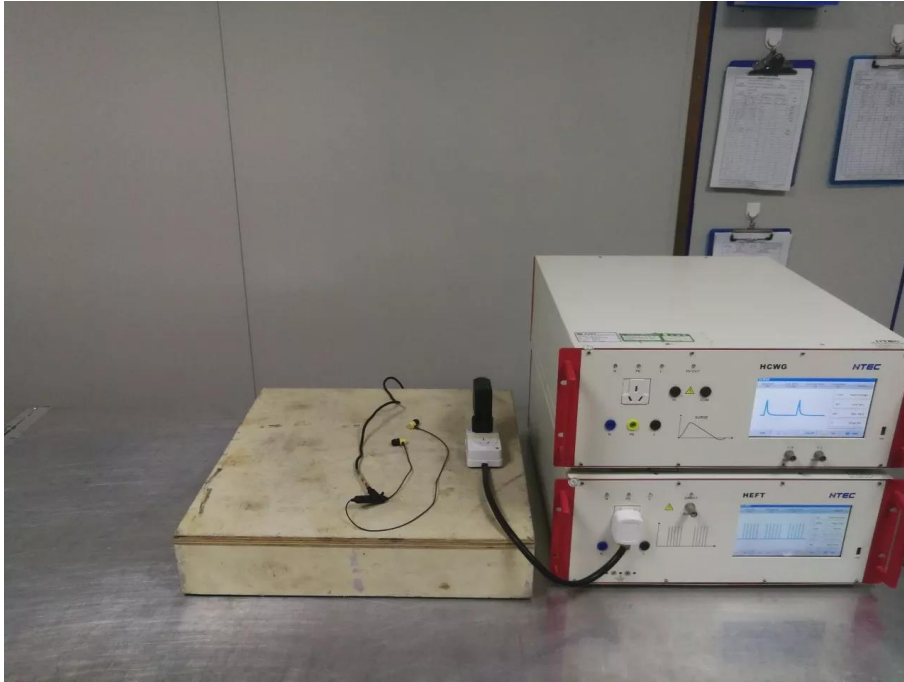

Surge

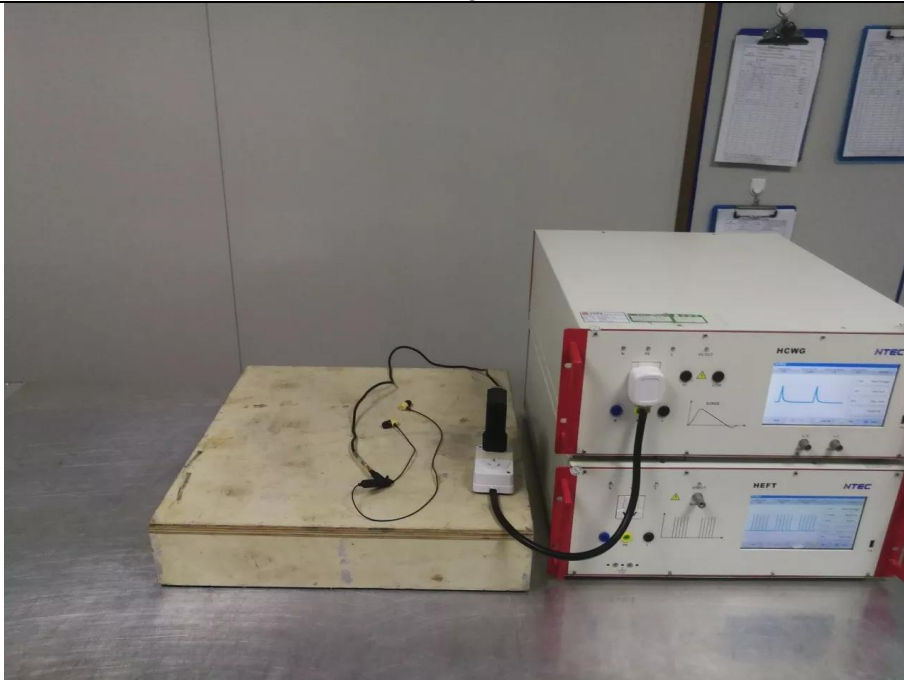

CS

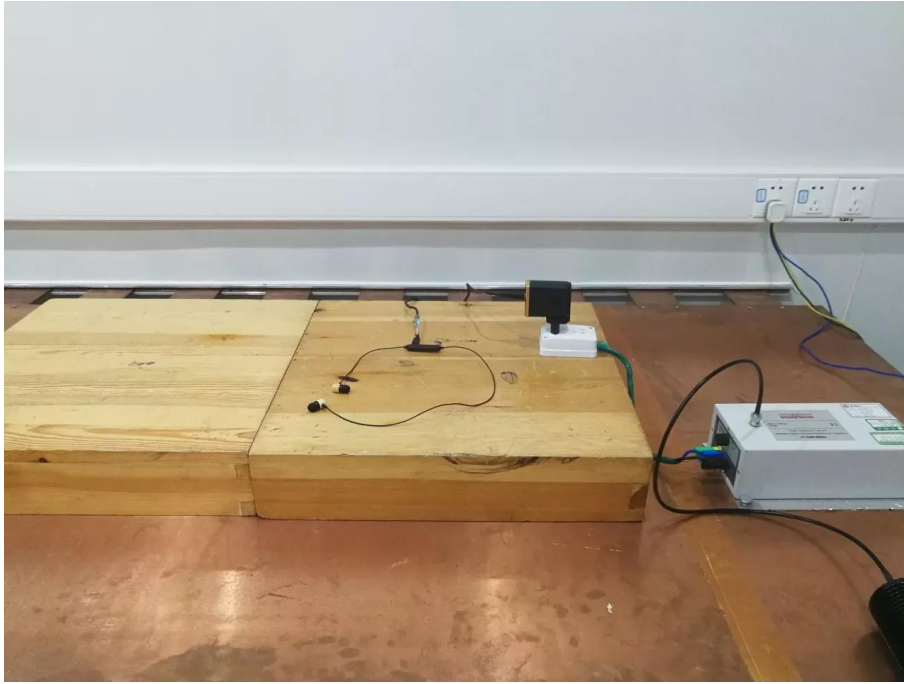

Dip

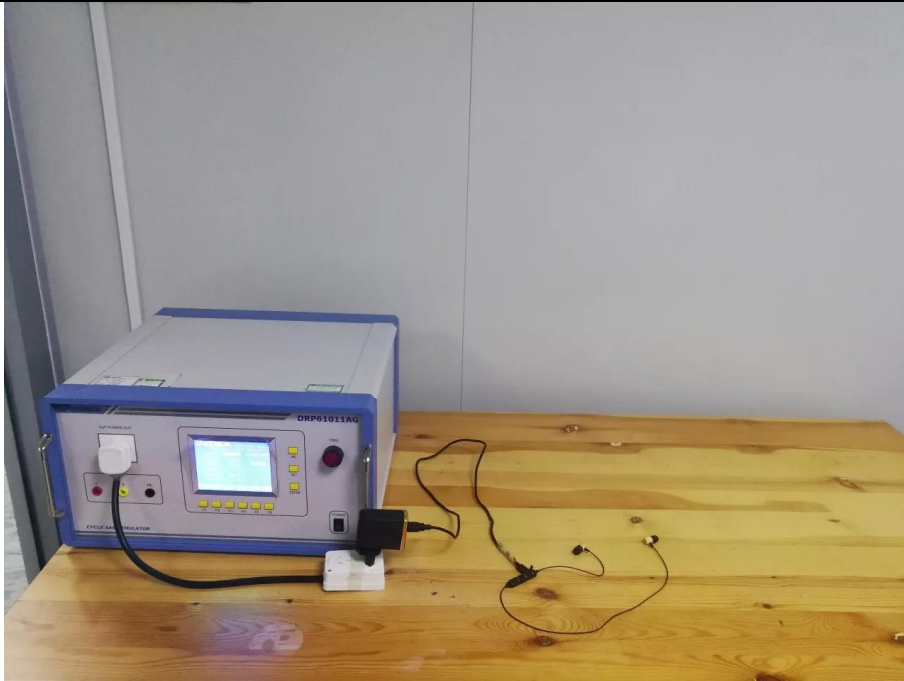

Photographs of the Test EUT

See the APPENDIX 1: EUT PHOTO in the report No.: MTi19061215-1B012-1E-1.

----END OF REPORT----