

RF TEST REPORT

Application No. : HX1906141804
Applicant :
Equipment Under Test (EUT)
EUT Name : Bluetooth Speaker
Model No. :
Serial No. : See Page 4
Brand Name : N/A
Receipt Date : 2019-06-05
Test Date : 2019-06-05 to 2019-06-13
Issue Date : 2019-06-14
Standards : ETSI EN 300 328 V2.1.1:2016
Conclusions : **PASS**

In the configuration tested, the EUT complied with the standards specified above

Test/Witness Engineer : *Tim Chen*

Approved & Authorized : *Andy Zhang*



This report details the results of the testing carried out on one sample. The results contained in this test report do not relate to other samples of the same product. The manufacturer should ensure that all products in series production are in conformity with the product sample detailed in the report.

TABLE OF CONTENTS

1	GENERAL INFORMATION	4
1.1	Client Information.....	4
1.2	General Description of EUT (Equipment Under Test)	4
1.3	Block Diagram Showing the Configuration of System Tested	6
1.4	Description of Support Units	6
1.5	Description of Operating Mode.....	6
1.6	Description of Test Software Setting	7
1.7	Test Facility.....	7
2	TEST RESULTS SUMMARY	8
3	MAXIMUM TRANSMIT POWER	10
3.1	Test Standard and Limit	10
3.2	Test Setup	10
3.3	Test Procedure	11
3.4	Test Equipment Used	11
3.5	Test Data	12
4	DUTY CYCLE, TX-SEQUENCY, TX-GAP	14
4.1	Test Standard and Limit	14
4.2	Test Setup	14
5	DWELL TIME, MINIMUM FREQUENCY OCCUPATION AND HOPPING SEQUENCE	15
5.1	Test Standard and Limit	15
5.2	Test Setup	15
5.3	Test Procedure	15
5.4	Test Equipment Used	16
5.5	Test Data	16
6	HOPPING FREQUENCY SEPARATION	30
6.1	Test Standard and Limit	30
6.2	Test Setup	30
6.3	Test Procedure	30
6.4	Test Equipment Used	31
6.5	Test Data	31
7	OCCUPIED CHANNEL BANDWIDTH.....	35
7.1	Test Standard and Limit	35
7.2	Test Setup	35
7.3	Test Procedure	35
7.4	Test Equipment Used	36
7.5	Test Data	36
8	MEDIUM UTILISATION (MU) FACTOR.....	41
8.1	Test Standard and Limit	41
8.2	Test Setup	41
9	ADAPTIVITY (ADAPTIVE FREQUENCY HOPPING).....	42
9.1	Test Standard and Limit	42
9.2	Test Setup	42

10	TANSMITTER UNWANTED EMISSIONS IN THE OUT-OF-BAND DOMAIN.....	43
10.1	Test Standard and Limit	43
10.2	Test Setup	43
10.3	Test Procedure	43
10.4	Test Equipment Used	44
10.5	Test Date	45
11	TRANSMITTER UNWANTED SPURIOUS EMISSIONS IN THE SPURIOUS DOMAIN	46
11.1	Test Standard and Limit	46
11.2	Test Setup	46
11.3	Test Procedure	47
11.4	Test Equipment Used	48
11.5	Test Date	49
12	RECEIVER SPURIOUS EMISSIONS.....	52
12.1	Test Standard and Limit	52
12.2	Test Setup	52
12.3	Test Procedure	53
12.4	Test Equipment Used	54
12.5	Test Date	55
13	RECEIVER BLOCKING	58
13.1	Test Standard and Limit	58
13.2	Test Setup	58
14	PHOTOGRAPHS - CONSTRUCTIONAL DETAILS	59

1 General Information

1.1 Client Information

Applicant	:	
Address	:	
Manufacturer	:	
Address	:	

1.2 General Description of EUT (Equipment Under Test)

EUT Name	:	Bluetooth Speaker	
Model No.	:	DSBT048	
Serial No.	:	N/A	
Model Difference	:	The different models are identical in schematic and critical component, the only different is the appearance.	
Product Description	:	Operation Frequency:	Bluetooth: 2402MHz~2480MHz
		Number of Channel:	79 Channels see note (2)
		Out Power	3.23 dBm 1Mbps 2.14 dBm 3Mbps
		Antenna Designation:	0 dbi see note (3)
		Modulation Type:	GFSK 1Mbps(1Mbps) π/4-DQPSK(2Mbps) 8-DPSK(3Mbps)
		Date Rate:	1~3 Mbps
Power Supply	:	DC 5.0V, 0.5A	
Connecting I/O Port(S)	:	Please refer to the User's Manual	

Note:

(1) For a more detailed features description, please refer to the manufacturer's specifications or the User's Manual.

(2) Channel List:

Channel	Frequency (MHz)	Channel	Frequency (MHz)	Channel	Frequency (MHz)
---------	-----------------	---------	-----------------	---------	-----------------

00	2402	27	2429	54	2456
01	2403	28	2430	55	2457
02	2404	29	2431	56	2458
03	2405	30	2432	57	2459
04	2406	31	2433	58	2460
05	2407	32	2434	59	2461
06	2408	33	2435	60	2462
07	2409	34	2436	61	2463
08	2410	35	2437	62	2464
09	2411	36	2438	63	2465
10	2412	37	2439	64	2466
11	2413	38	2440	65	2467
12	2414	39	2441	66	2468
13	2415	40	2442	67	2469
14	2416	41	2443	68	2470
15	2417	42	2444	69	2471
16	2418	43	2445	70	2472
17	2419	44	2446	71	2473
18	2420	45	2447	72	2474
19	2421	46	2448	73	2475
20	2422	47	2449	74	2476
21	2423	48	2450	75	2477
22	2424	49	2451	76	2478
23	2425	50	2452	77	2479
24	2426	51	2453	78	2480
25	2427	52	2454		
26	2428	53	2455		

(3) Antenna description

Ant.	Brand	Model Name	Antenna Type	Gain(dBi)
1	N/A	N/A	Printed Ant	0

1.3 Block Diagram Showing the Configuration of System Tested

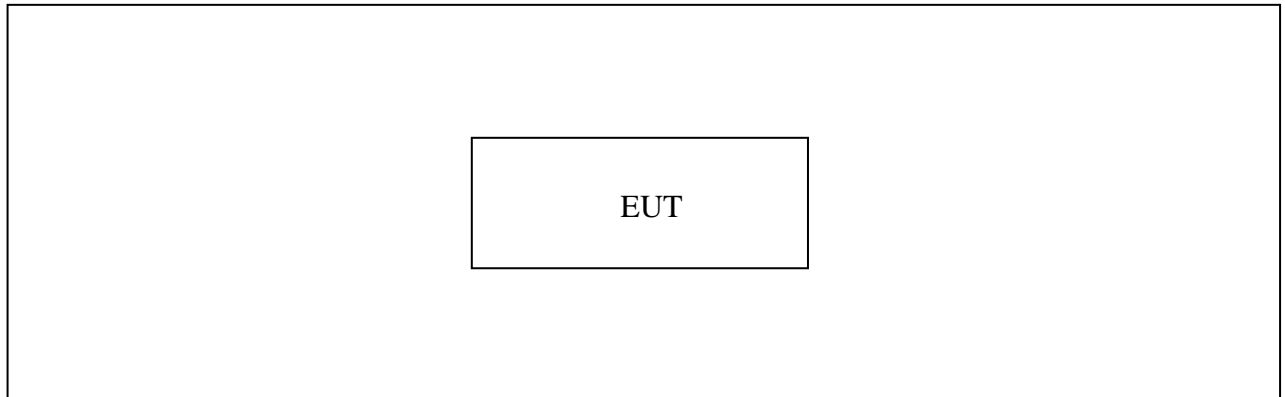

1.4 Description of Support Units

The EUT has been tested as an independent unit.

Name	Model	S/N	Manufacturer	Used “√”

1.5 Description of Operating Mode

To investigate the maximum EMI emission characteristics generated from EUT, the test system was pre-scanning tested based on the consideration of following EUT operation mode or test configuration mode which possible have effect on EMI emission level. Each of these EUT operation mode(s) or test configuration mode(s) mentioned above was evaluated respectively.

METAL SPEAKR WITH BLUETOOTH AND HANDSFREE	
Lowest Channel	CH00 2402MHz
Middle Channel	CH39 2441MHz
Highest Channel	CH78 2480MHz

Test Items	Mode	Data Rate	Channel
Transmitter Spurious Emissions (1GHz~12.75GHz)	GFSK	1Mbps	2402/2441/2480MHz
Receiver Spurious Emissions (1GHz~12.75GHz)	GFSK	1Mbps	2402/2441/2480MHz

1.6 Description of Test Software Setting

During testing channel & Power controlling software provided by the customer was used to control operating channel as well as the output power level. The RF output power selection is for setting of RF output power expected by the customer and is going to be fixed on the firmware of the final end product power parameters of Bluetooth mode.

1.7 Test Facility

The testing report were performed by the Shenzhen HX Detect Certification Co., Ltd., in their facilities located at 8/F, Haoyunlai Building B, Baomin 2th Road, Xixing Street, Baoan District, Shenzhen, China.

2 TEST RESULTS SUMMARY

ETSI EN 300 328 V2.1.1							
Essential Requirement			Requirement Conditionality		Test Specification		
No	Description	Reference : Clause No	U/C	Condition	E/O	Reference: Clause No	Observations
1	RF Output Power	4.3.1.1 or 4.3.2.1	U		E	5.3.2	PASS Note (2)
2	Power Spectral Density	4.3.2.2	C	Only for modulations other than FHSS	E	5.3.3	N/A
3	Duty cycle, TX-Sequence, TX-gap	4.3.1.2 or 4.3.2.3	C	Only for non-adaptive equipment	E	5.3.2	N/A Note (3)
4	Dwell time, Minimum Frequency Occupation & Hopping Sequence	4.3.1.3	C	Only for FHSS	E	5.3.4	PASS
5	Hopping Frequency Separation	4.3.1.4	C	Only for FHSS	E	5.3.5	PASS
6	Medium Utilisation	4.3.1.5 or 4.3.2.4	C	Only for non-adaptive equipment	E	5.3.2	N/A Note (3)
7	Adaptivity	4.3.1.6 or 4.3.2.5	C	Only for non-adaptive equipment	E	5.3.3	N/A Note (3)
8	Occupied Channel Bandwidth	4.3.1.7 or 4.3.2.6	U		E	5.3.8	PASS
9	Transmitter unwanted emissions in the OOB domain	4.3.1.8 or 4.3.2.7	U		E	5.3.9	PASS
10	Transmitter unwanted emissions in the spurious domain	4.3.1.9 or 4.3.2.8	U		E	5.3.10	PASS
11	Receiver spurious emissions	4.3.1.10 or 4.3.2.9	U		E	5.3.11	PASS
12	Receiver Blocking	4.3.1.11 or 4.3.2.10	C	Only for adaptive equipment	E	5.3.7	N/A Note (3)

Note:

- (1) "U/C": indicates whether the requirement is to be unconditionally applicable (U) or is conditional upon the manufacturers claimed functionality of the equipment (C).
"E/O": indicates whether the test specification forms part of the Essential Radio Test Suite (E) or whether it is one of the Other Test Suite (O).
"X": indicates there is no test specified corresponding to the requirement.
"N/A": indicates test is not applicable in this Test Report.
- (2) The equipment must be complied with as a necessary condition for presumption of conformity, although conformance with the requirement may be claimed by an equivalent test or by manufacturer's assertion supported by appropriate entries in the technical construction file.
- (3) This requirement does not apply for equipment with a maximum declared RF Output power level of less than 10 dBm e.i.r.p. for equipment when operating in a mode where the RF Output power is less than 10 dBm e.i.r.p.
- (4) The equipment was supplied by Host system, so the upper extreme test voltage shall be 1.1 times the nominal voltage of the battery, and the lower extreme test voltage shall be 0.9 times the nominal voltage of the Host system.

3 Maximum Transmit Power

3.1 Test Standard and Limit

3.1.1 Test Standard

ETSI EN 300 328 V2.1.1: 2016 clause 4.3.1.1

3.1.2 Test Limit

Test Item	Limit
Equivalent isotropic radiated power	20 dBm

3.2 Test Setup

Normal Condition

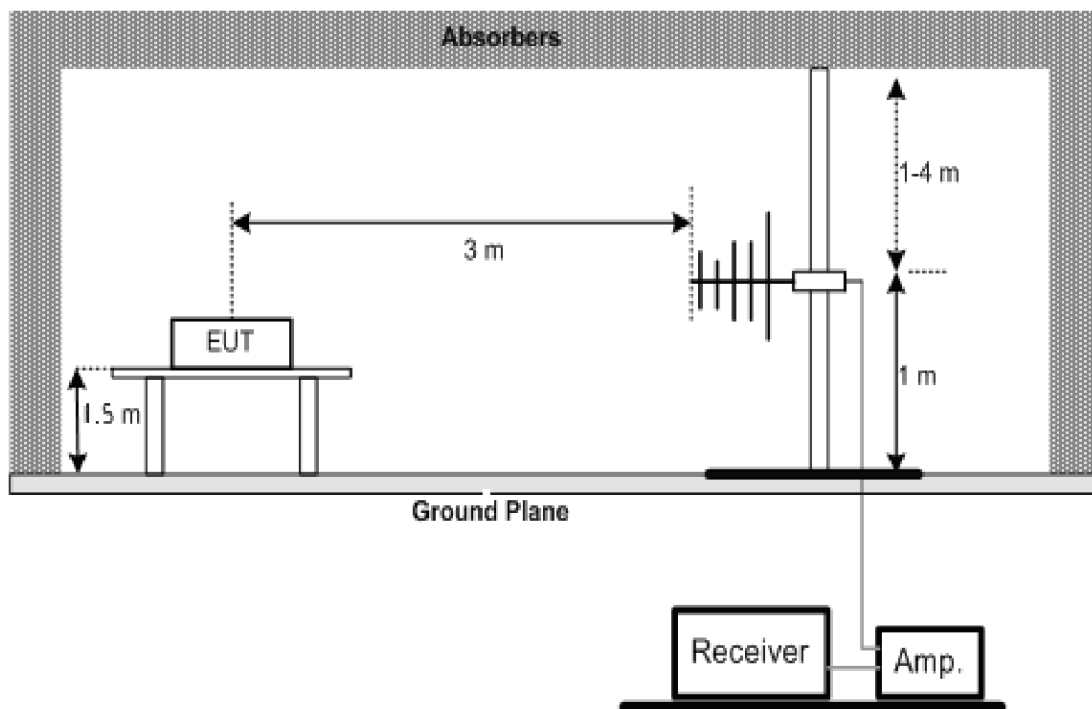

Extreme Condition

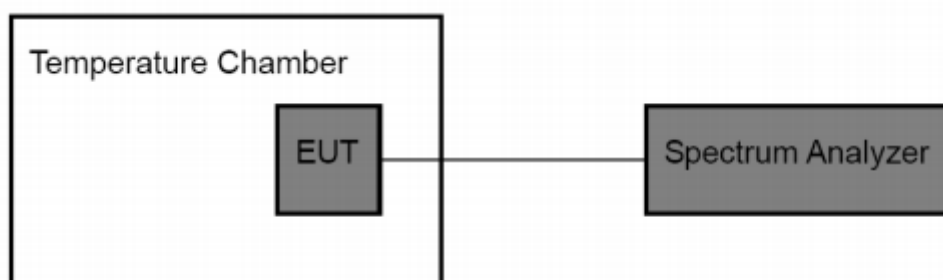

3.3 Test Procedure

1. The EUT was placed on the top of the turntable in chamber.
2. The test shall be made in the transmitting mode. The turntable was rotated by 360 degrees to determine the position of the highest radiation.
3. This measurement shall be repeated with the transmitter in standby mode where applicable.
4. The receiver shall be set the center frequency equal to the EUT transmit, and the Resolution Bandwidth equal to the Video Bandwidth is set to 1 MHz for the frequency bellow 1 GHz, and the frequency is above 1 GHz the Resolution Bandwidth equal to the Video Bandwidth is set to 3MHz.
5. The broadband receiving antenna was fixed on the same height with the EUT to find each suspected emissions of both horizontal and vertical polarization. Each recorded suspected value is indicated as Read Level (Raw).
6. Replace the EUT by standard antenna and feed the RF port by signal generator.
7. The $EIRP=A+G+10*\log(1/x)$, the A is the power measured in the above, and G is the gain of the antenna of the EUT in dBi and x is the duty cycle of the EUT in continuously transmitting mode.
8. The measurement shall be repeated at the lowest, the middle, and the highest channel of the stated frequency range. These measurements shall also be performed at the normal and the extreme test conditions.

3.4 Test Equipment Used

Description	Manufacturer	Model No.	Serial No.	Last Cal.	Cal. Interval
Spectrum Analyzer	ROHDE& SCHWARZ	FSEA20	DE25181	2019-01-02	1 Year
Positioning Controller	C&C	CC-C-1F	N/A	2019-01-02	1 Year
Trilog Broadband Antenna	SCHWARZBECK	VULB9163	9163-333	2019-01-02	1 Year
Horn Antenna	SCHWARZBECK	BBHX 9120	9120-426	2019-01-02	1 Year
RF Switch	EM	EMSW18	SW060023	2019-01-02	1 Year
Amplifier	Agilent	8447F	3113A0671	2019-01-02	1 Year
Coaxial Cable	SCHWARZBECK	AK9513	9513-10	2019-01-02	1 Year
EMI Test Receiver	ROHDE&SCHWAR	ESPI	25498514	2019-01-02	1 Year

3.5 Test Data

EUT:				Bluetooth Speaker	Model Name :	DSBT048	
Temperature:				23°C	Relative Humidity:	60%	
Pressure:				1010 hPa	Test Voltage :	DC3.7V	
Test Conditions:				1Mbps Continuous transmitting			
Test Mode : 2402 MHz				Test Result			
				EIRP (dBm)		EIRP Limits(dBm)	
T nom	20.0°C	V nom	3.70V	3.11	20	PASS	
T min	0.0°C	V max	4.07V	3.16	20	PASS	
		V min	3.51V	3.23	20	PASS	
T max	55.0°C	V max	4.07V	3.13	20	PASS	
		V min	3.51V	3.19	20	PASS	
Test Mode : 2441 MHz				Test Result			
				EIRP (dBm)		EIRP Limits(dBm)	
T nom	20.0°C	V nom	3.70V	2.71	20	PASS	
T min	0.0°C	V max	4.07V	2.77	20	PASS	
		V min	3.51V	2.84	20	PASS	
T max	55.0°C	V max	4.07V	2.74	20	PASS	
		V min	3.51V	2.80	20	PASS	
Test Mode : 2480 MHz				Test Result			
				EIRP (dBm)		EIRP Limits(dBm)	
T nom	20.0°C	V nom	3.70V	2.47	20	PASS	
T min	0.0°C	V max	4.07V	2.54	20	PASS	
		V min	3.51V	2.61	20	PASS	
T max	55.0°C	V max	4.07V	2.53	20	PASS	
		V min	3.51V	2.49	20	PASS	

EUT:				Bluetooth Speaker	Model Name :	DSBT048	
Temperature:				23°C	Relative Humidity:	60%	
Pressure:				1010 hPa	Test Voltage :	DC3.7V	
Test Conditions:				3Mbps Continuous transmitting			
Test Mode : 2402 MHz				Test Result			
				EIRP (dBm)		EIRP Limits(dBm)	
T nom	20.0°C	V nom	3.70V	2.01	20	PASS	
T min	0.0°C	V max	4.07V	2.05	20	PASS	
		V min	3.51V	2.14	20	PASS	
T max	55.0°C	V max	4.07V	2.03	20	PASS	
		V min	3.51V	2.10	20	PASS	
Test Mode : 2441 MHz				Test Result			
				EIRP (dBm)		EIRP Limits(dBm)	
T nom	20.0°C	V nom	3.70V	1.62	20	PASS	
T min	0.0°C	V max	4.07V	1.67	20	PASS	
		V min	3.51V	1.74	20	PASS	
T max	55.0°C	V max	4.07V	1.65	20	PASS	
		V min	3.51V	1.70	20	PASS	
Test Mode : 2480 MHz				Test Result			
				EIRP (dBm)		EIRP Limits(dBm)	
T nom	20.0°C	V nom	3.70V	1.59	20	PASS	
T min	0.0°C	V max	4.07V	1.56	20	PASS	
		V min	3.51V	1.61	20	PASS	
T max	55.0°C	V max	4.07V	1.54	20	PASS	
		V min	3.51V	1.57	20	PASS	

4 Duty Cycle, Tx-Sequence, Tx-gap

4.1 Test Standard and Limit

4.1.1 Test Standard

ETSI EN 300 328 V2.1.1: 2016 clause 4.3.1.2

4.1.2 Test Limit

Test Item	Limit
FHSS equipment	The maximum Tx-sequence time shall be 5 ms while the minimum Tx-gap time shall be 5 ms. For non-adaptive FHSS equipment: Duty Cycle shall be equal to or less than the maximum value declared by the supplier.

The frequency range of the equipment is determined by the lowest and highest frequencies occupied by the spectrum envelope.

fH is the highest frequency of the spectrum envelope: it is the frequency furthest above the frequency of maximum power where the e.i.r.p. spectral density drops below the level of -80 dBm/Hz (-30 dBm if measured in a 100 kHz bandwidth).

fL is the lowest frequency of the spectrum envelope; it is the frequency furthest below the frequency of maximum power where the e.i.r.p. spectral density drops below the level of -80 dBm/Hz (or -30 dBm if measured in a 100 kHz bandwidth).

For a given operating frequency, the width of the spectrum envelope is (fH - fL). In equipment that allows adjustment or selection of different operating frequencies, the power envelope takes up different positions in the allocated band. The frequency range is determined by the lowest value of fL and the highest value of fH resulting from the adjustment of the equipment to the lowest and highest operating frequencies.

4.2 Test Setup

These requirements do not apply for equipment with a maximum declared RF Output power of less than 10 dBm e.i.r.p or for equipment when operating in a mode where the RF Output power is less than 10 dBm e.i.r.p.

Note:

The Equipment e.i.r.p. power is less than 10 dBm, so no requirement for this test item.

5 Dwell Time, Minimum Frequency Occupation and Hopping Sequence

5.1 Test Standard and Limit

5.1.1 Test Standard

ETSI EN 300 328 V2.1.1: 2016 clause 4.3.1.3

5.1.2 Limits

Test Item	Frequency Range (MHz)	Limit	Result
Dwell Time	2400-2483.5	0.4s	PASS
Minimum Frequency Occupation Time		Not exceeding four times of the dwell time per hop and the number of hopping frequencies in use	PASS
Hopping Sequence		At least 15 hopping frequencies at all times	PASS

5.2 Test Setup

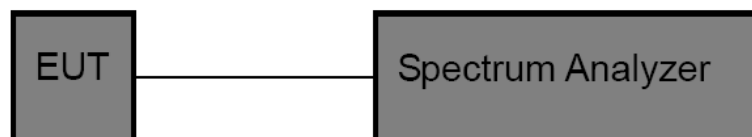

5.3 Test Procedure

1. The transmitter output was connected to the spectrum analyzer.
2. Set Resolution Bandwidth of the spectrum analyzer to 1MHz and Video Bandwidth to 1MHz.
3. Use a video trigger with the trigger level set to enable triggering only on full pulses.
4. Sweep Time is more than once pulse time.
5. Set the center frequency on any frequency would be measured and set the frequency span to zero span.
6. Measure the maximum time duration of one single pulse.
7. Set the EUT for DH5, DH3 and DH1 packet transmitting.
8. Measure the maximum time duration of one single pulse.
9. DH5 Packet permit maximum $1600/79/6=3.37$ hops per second in each channel (5 time

slots RX, 1 time slot TX). So, the dwell time is the time duration of the pulse times $3.37 * 31.6=106.6$ with 31.6 seconds.

DH3 Packet permit maximum $1600/79/4=5.06$ hops per second in each channel (3 time slots RX, 1 time slot TX). So, the dwell time is the time duration of the pulse times $5.06 * 31.6=160$ with 31.6 seconds.

DH1= Packet permit maximum $1600/79/2=10.12$ hops per second in each channel (1 time slot RX, 1time slot TX).So, the dwell time is

the time duration of the pulse times $10.12 * 31.6=320$ within 31.6 seconds.

10. The lowest, middle and highest frequency of the EUT should be tested.

5.4 Test Equipment Used

Description	Manufacturer	Model No.	Serial No.	Last Cal.	Cal. Interval
Spectrum Analyzer	ROHDE& SCHWARZ	FSEA20	DE25181	2019-01-02	1 Year
DC power supply	GVE	PL0825	N/A	N/A	N/A
Temp.&Humid. Chamber	GIANT	IHT-550	IKW682-054	2019-01-02	1 Year

5.5 Test Data

(1) Dwell Time

EUT:	Bluetooth Speaker	Model Name :	DSBT048
Temperature:	23°C	Relative Humidity :	60%
Pressure:	1010 hPa	Test Voltage :	DC3.7V
Test Mode:	2402MHz (DH1/DH3/DH5) 1Mbps		

Data Packet	Frequency (MHz)	Pulse Duration (ms)	Dwell Time (s)	Limits (s)
DH1	2402	0.560	0.179	0.400
DH3	2402	1.820	0.291	0.400
DH5	2402	3.060	0.326	0.400

DH1

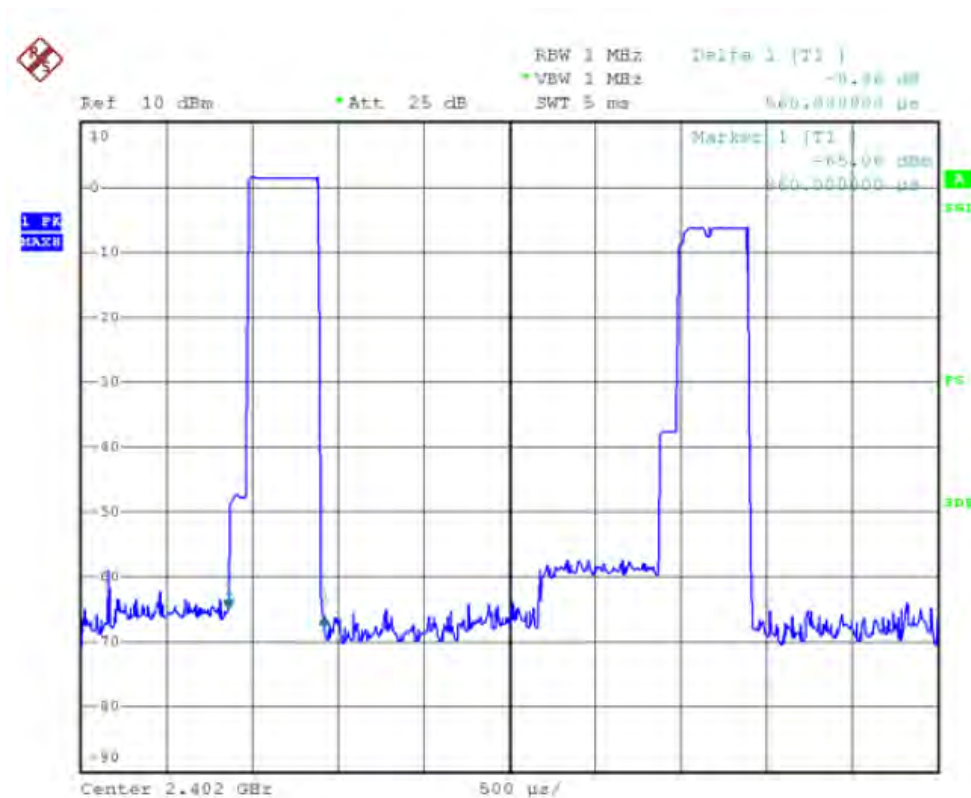

DH3

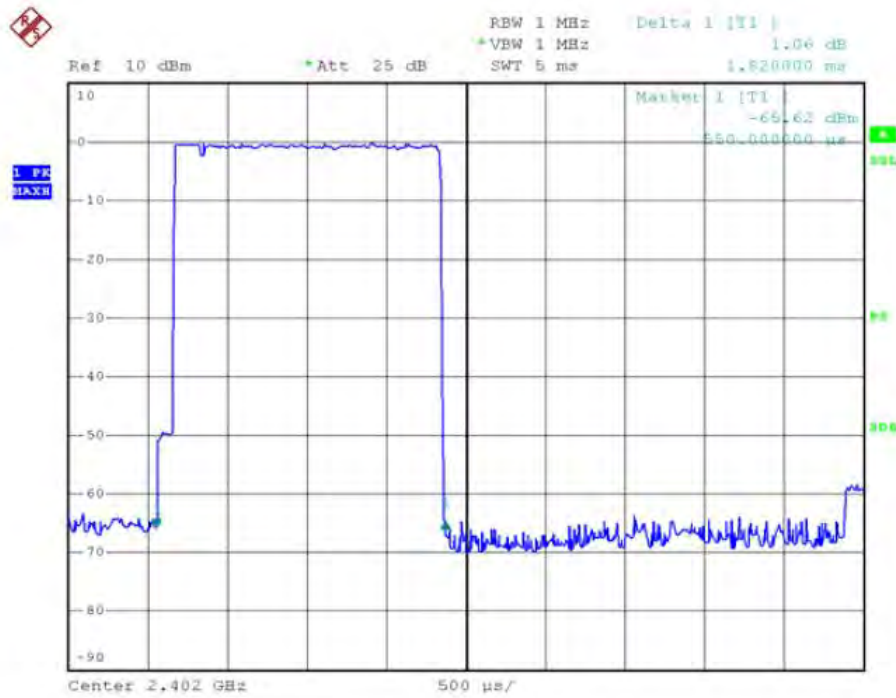

DH5

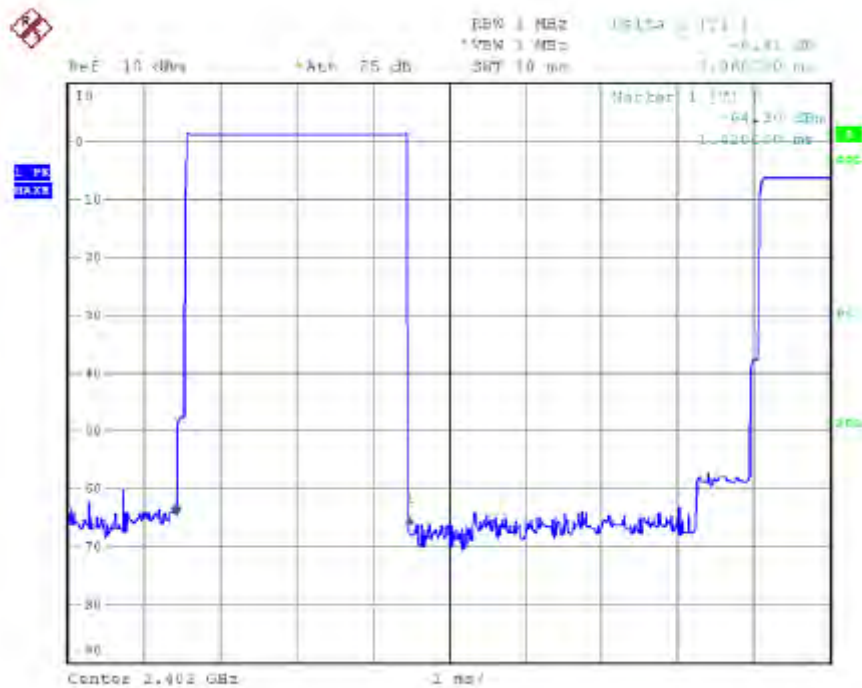

EUT:	Bluetooth Speaker	Model Name :	DSBT048
Temperature:	23°C	Relative Humidity :	60%
Pressure:	1010 hPa	Test Voltage :	DC3.7V
Test Mode:	2441MHz (DH1/DH3/DH5) 1Mbps		

Data Packet	Frequency (MHz)	Pulse Duration (ms)	Dwell Time (s)	Limits (s)
DH1	2441	0.560	0.179	0.400
DH3	2441	1.820	0.291	0.400
DH5	2441	3.060	0.326	0.400

DH1

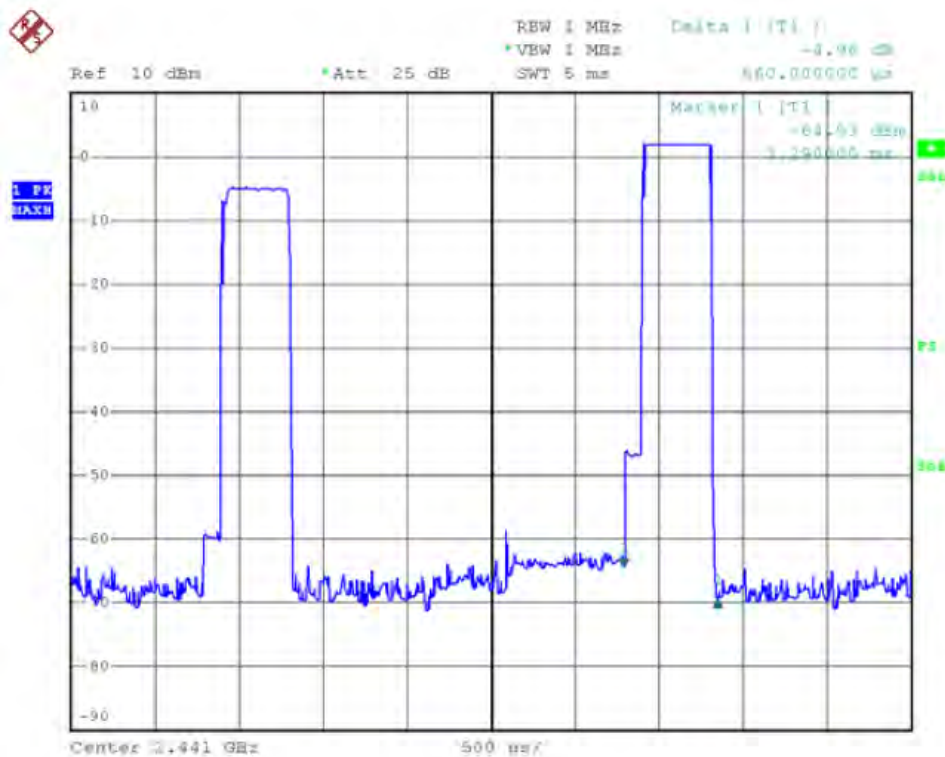

DH3

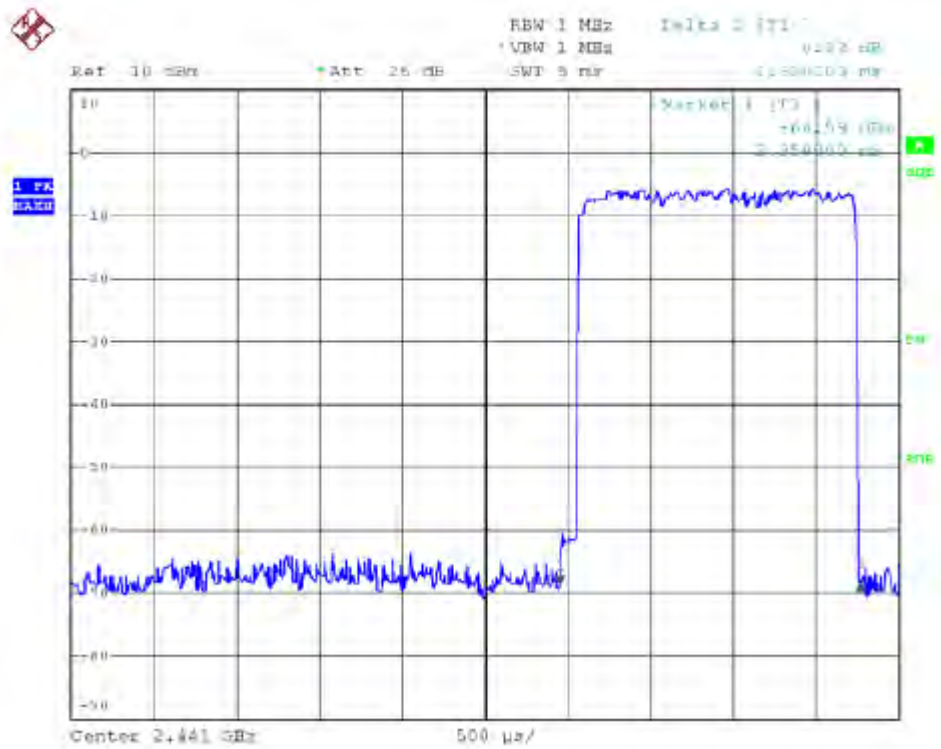

DH5

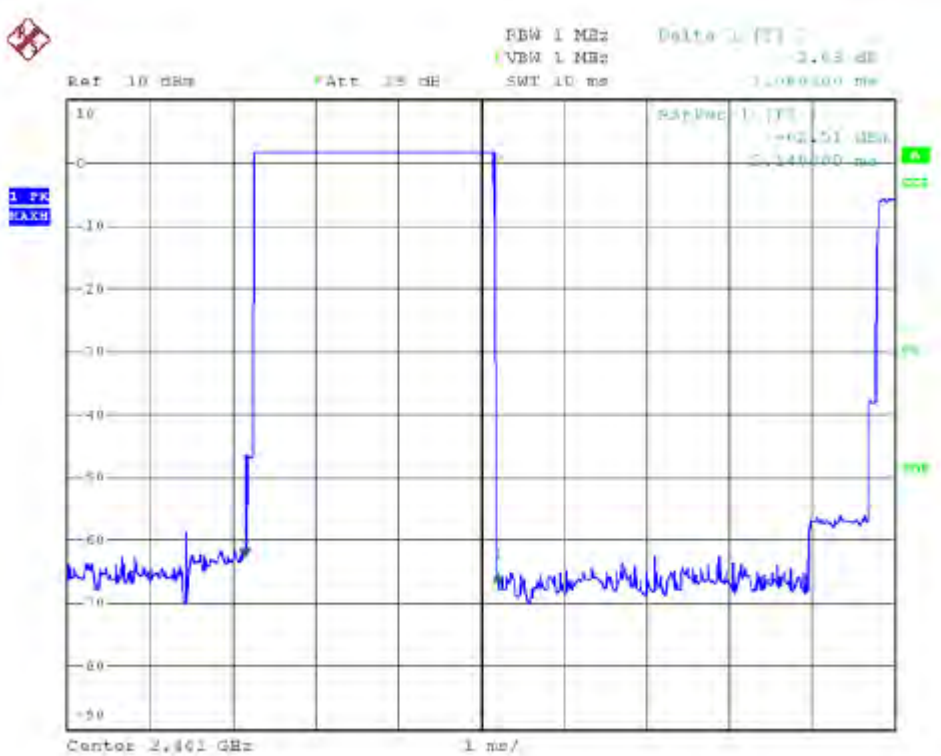

EUT:	Bluetooth Speaker	Model Name :	DSBT048
Temperature:	23°C	Relative Humidity :	60%
Pressure:	1010 hPa	Test Voltage :	DC3.7V
Test Mode:	2480MHz(DH1/DH3/DH5) 1Mbps		

Data Packet	Frequency (MHz)	Pulse Duration (ms)	Dwell Time (s)	Limits (s)
DH1	2480	0.560	0.179	0.400
DH3	2480	1.820	0.291	0.400
DH5	2480	3.060	0.326	0.400

DH1

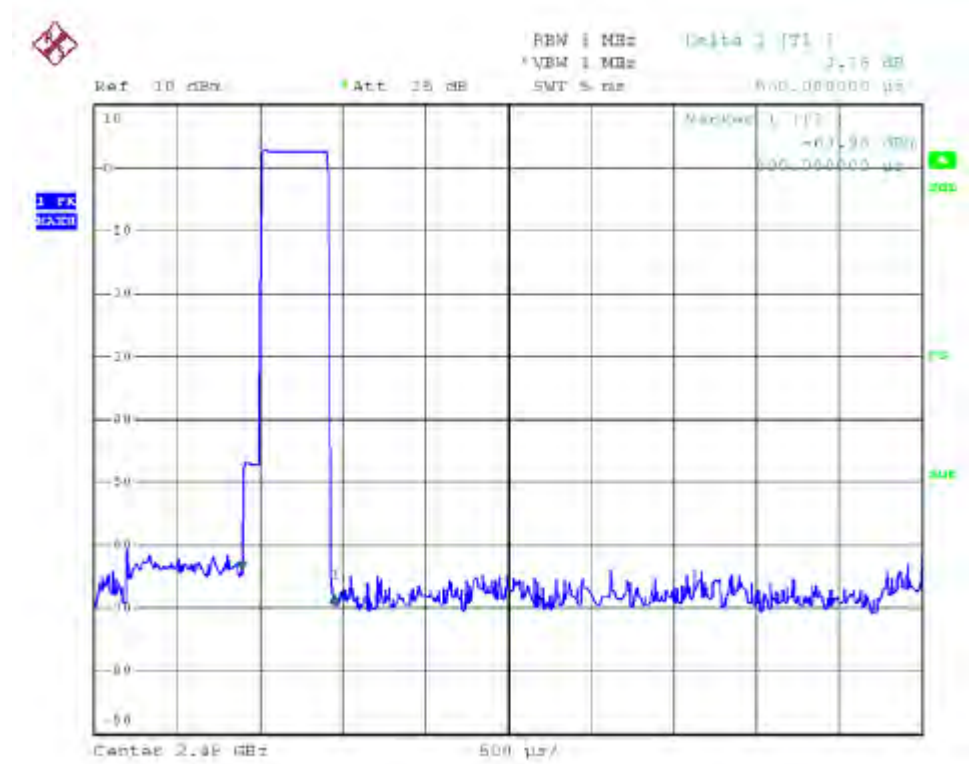

DH3

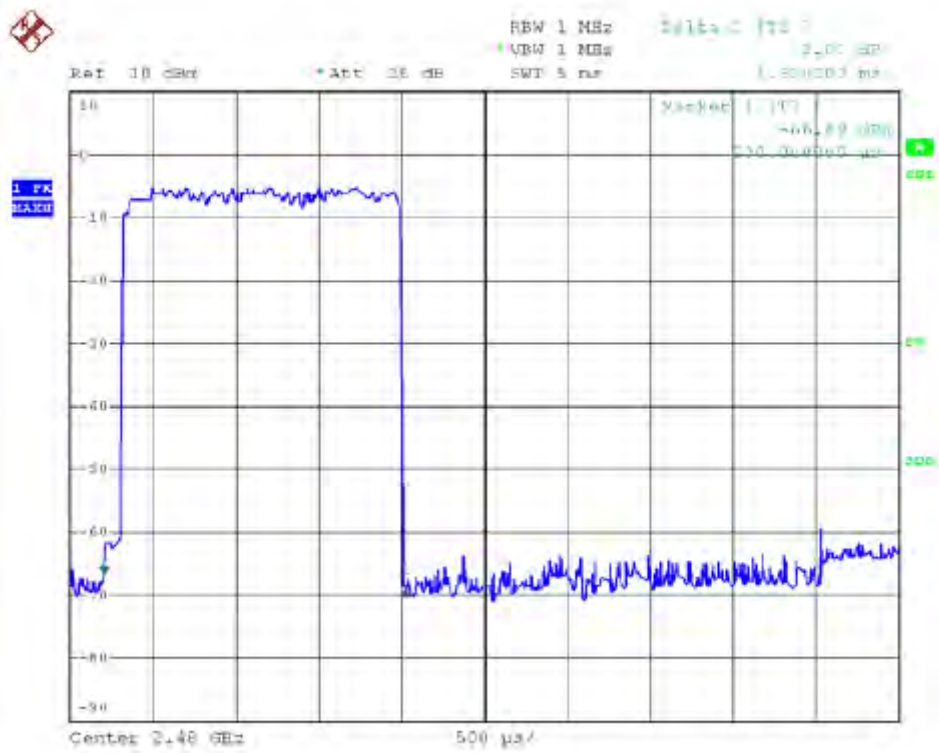

DH5

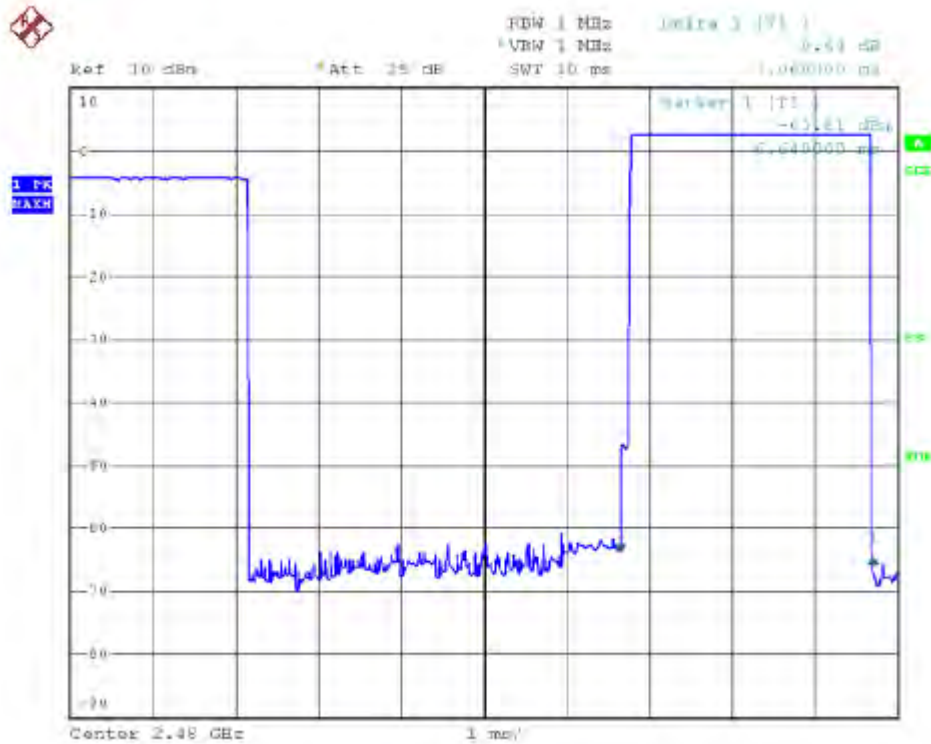

EUT:	Bluetooth Speaker	Model Name :	DSBT048
Temperature:	23°C	Relative Humidity :	60%
Pressure:	1010 hPa	Test Voltage :	DC3.7V
Test Mode:	2402MHz (DH1/DH3/DH5) 3Mbps		

Data Packet	Frequency (MHz)	Pulse Duration (ms)	Dwell Time (s)	Limits (s)
DH1	2402	0.570	0.182	0.400
DH3	2402	1.820	0.291	0.400
DH5	2402	3.100	0.330	0.400

DH1

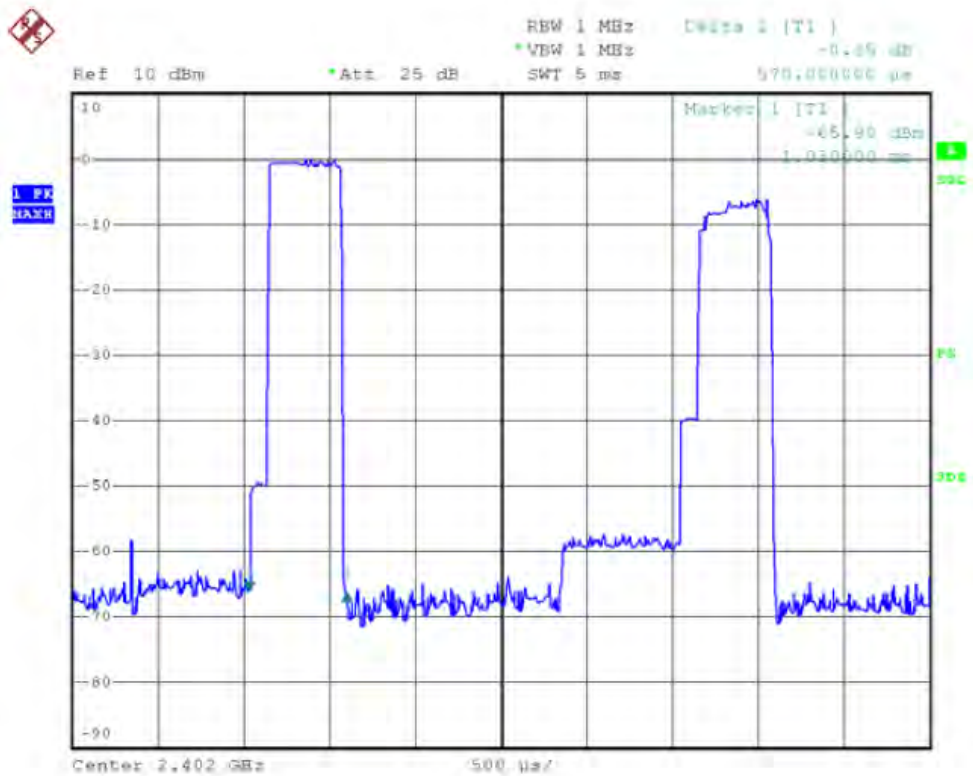

DH3

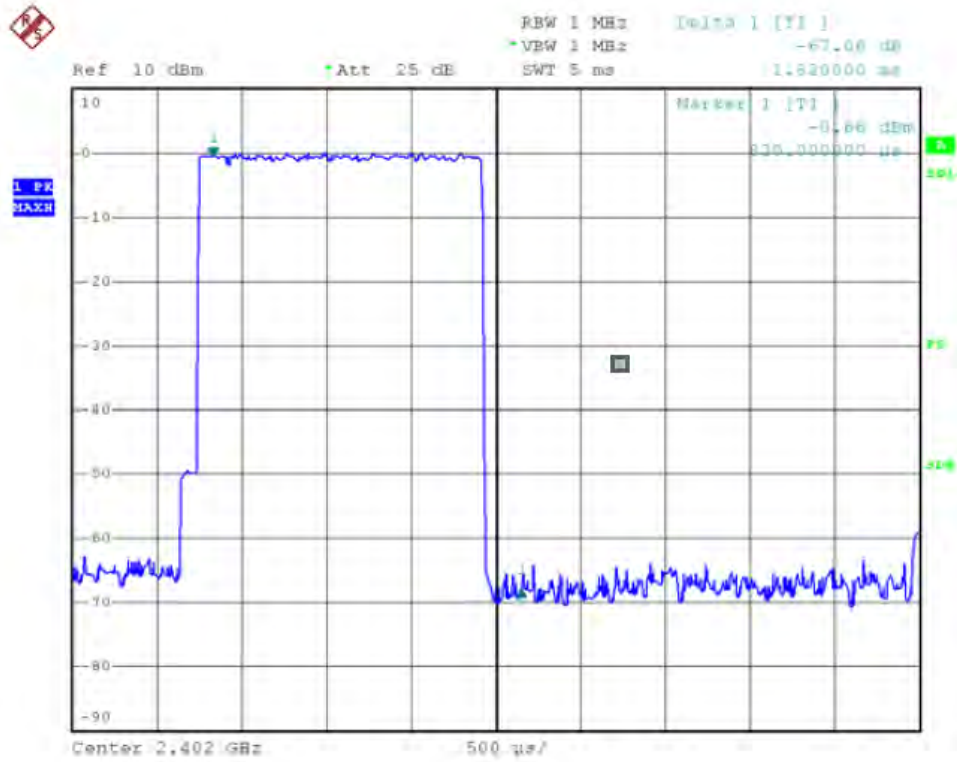

DH5

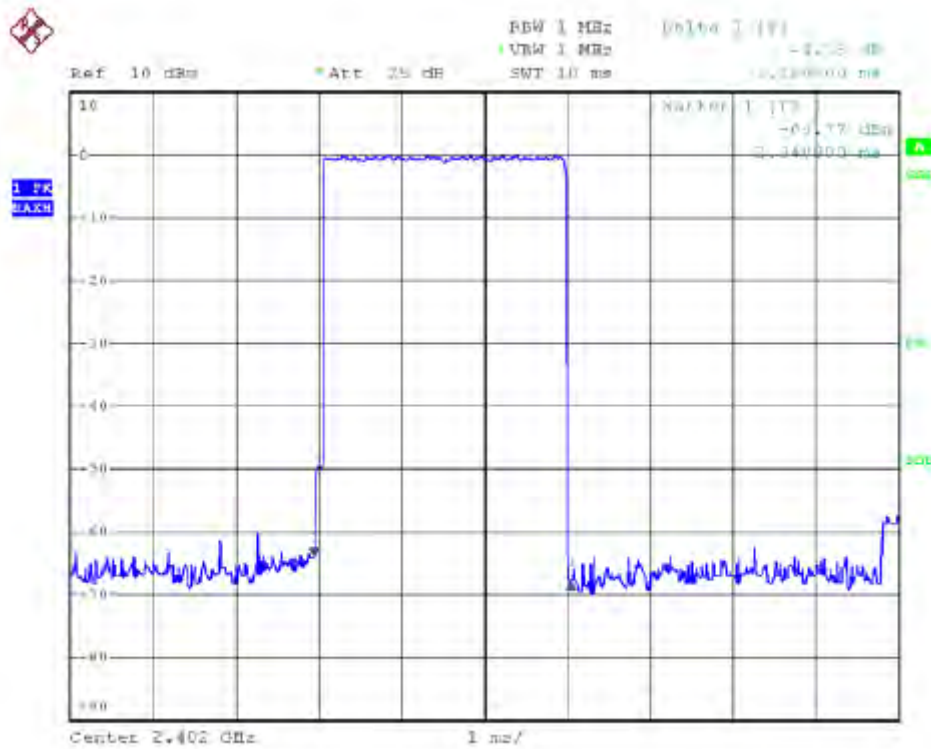

EUT:	Bluetooth Speaker	Model Name :	DSBT048
Temperature:	23°C	Relative Humidity :	60%
Pressure:	1010 hPa	Test Voltage :	DC3.7V
Test Mode:	2441MHz (DH1/DH3/DH5) 3Mbps		

Data Packet	Frequency (MHz)	Pulse Duration (ms)	Dwell Time (s)	Limits (s)
DH1	2441	0.570	0.182	0.400
DH3	2441	1.800	0.288	0.400
DH5	2441	3.100	0.330	0.400

DH1

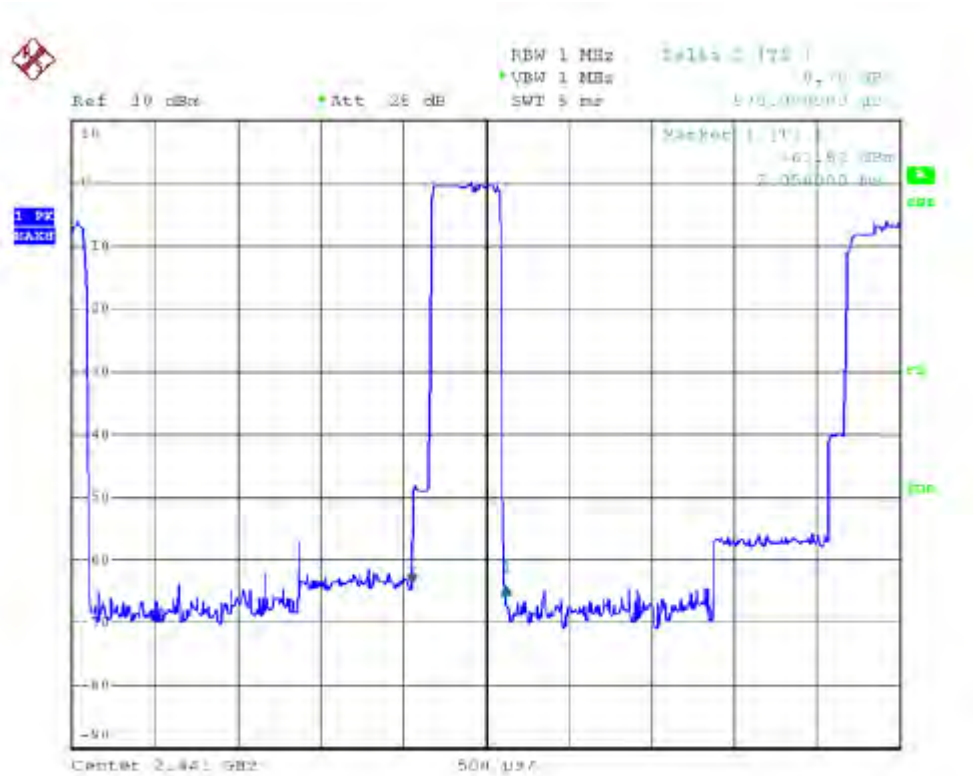

DH3

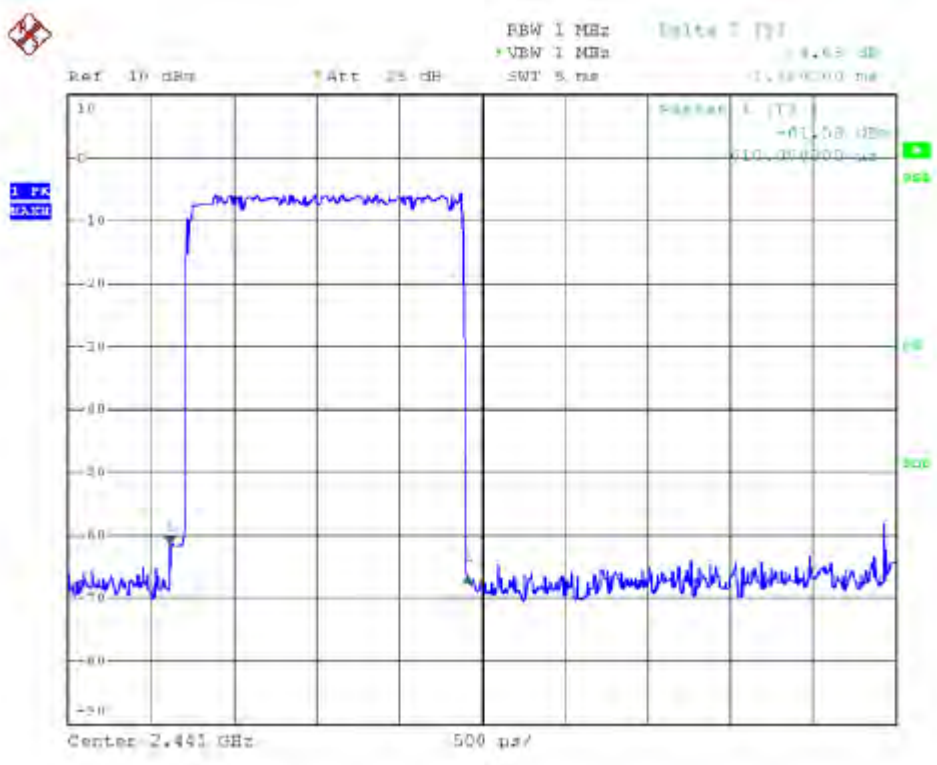

DH5

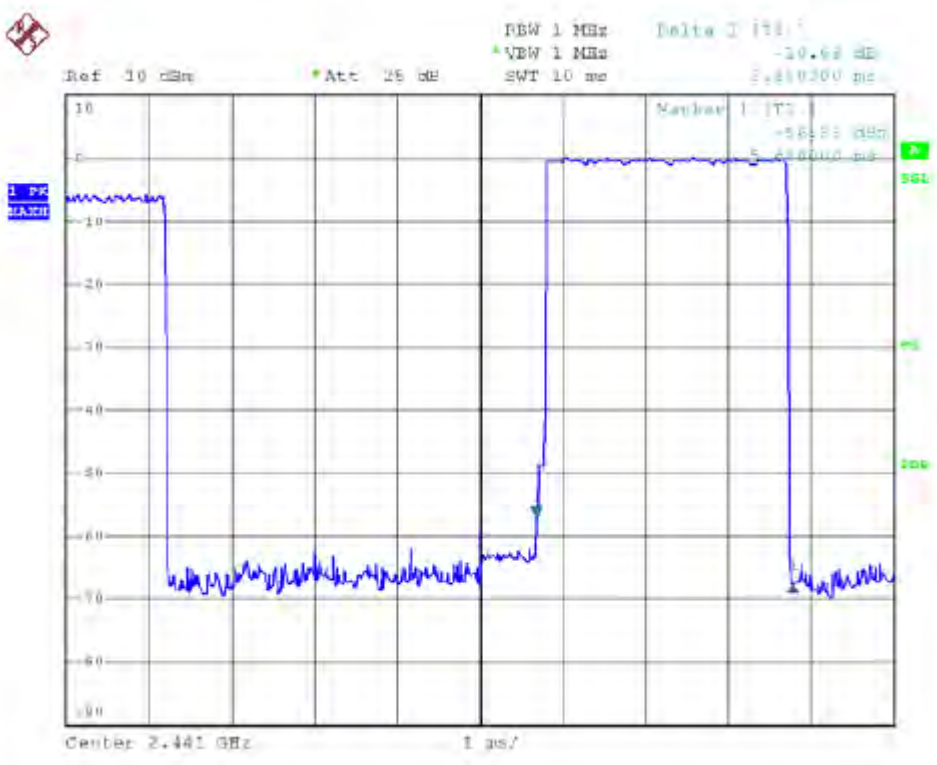

EUT:	Bluetooth Speaker	Model Name :	DSBT048
Temperature:	23°C	Relative Humidity :	60%
Pressure:	1010 hPa	Test Voltage :	DC3.7V
Test Mode:	2480MHz(DH1/DH3/DH5) 3Mbps		

Data Packet	Frequency (MHz)	Pulse Duration (ms)	Dwell Time (s)	Limits (s)
DH1	2480	0.570	0.182	0.400
DH3	2480	1.820	0.291	0.400
DH5	2480	3.100	0.330	0.400

DH1

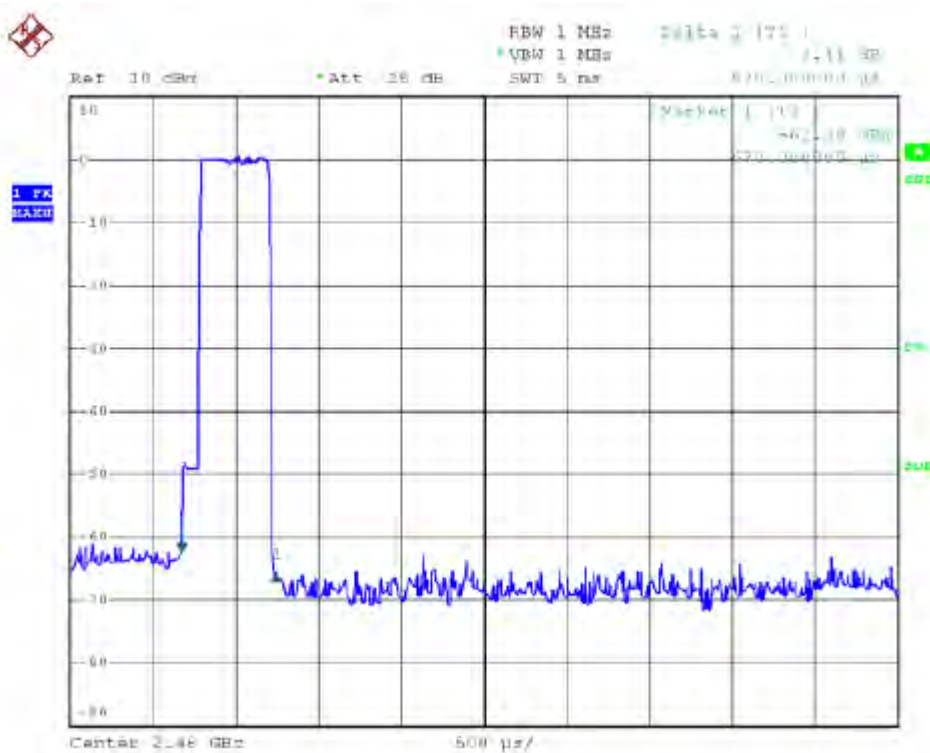

DH3

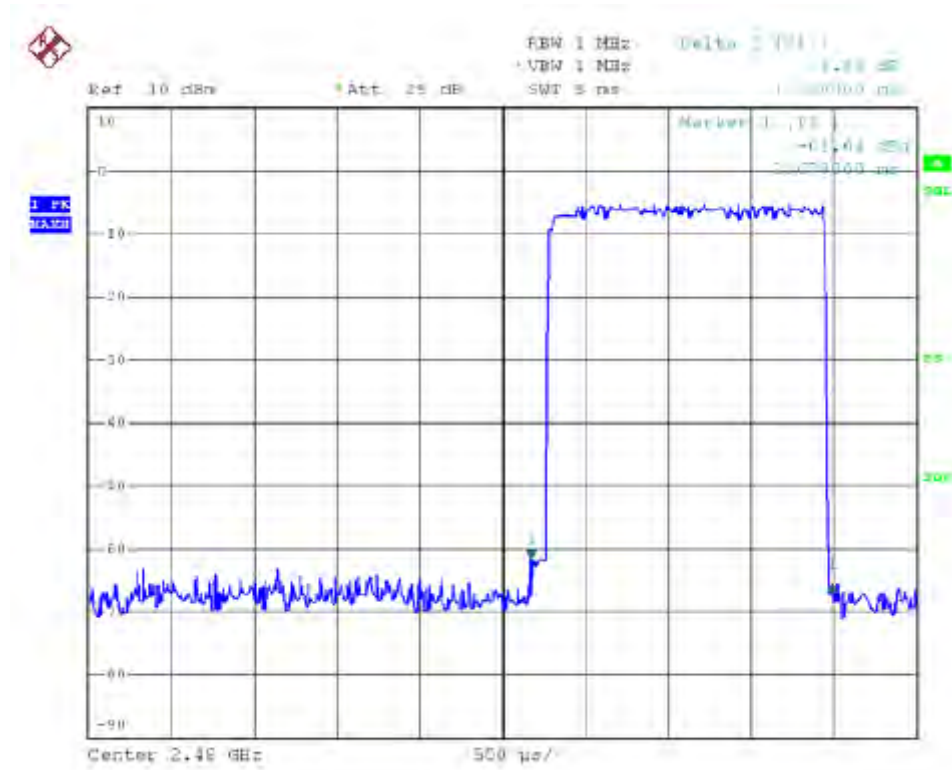

DH5

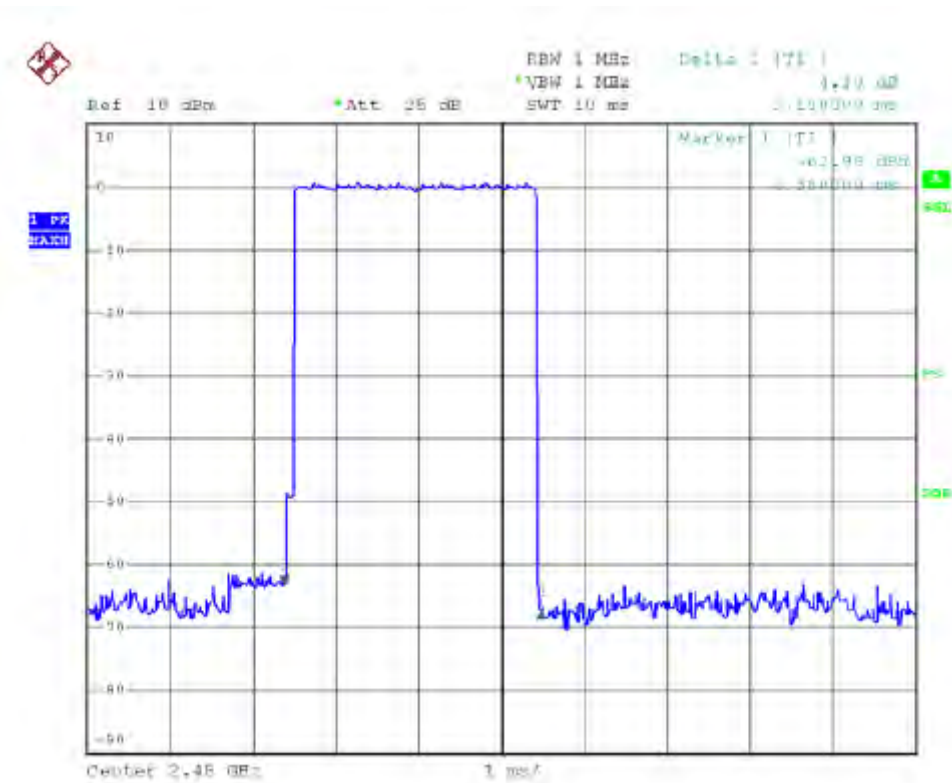

(2) Hopping Channel Numbers

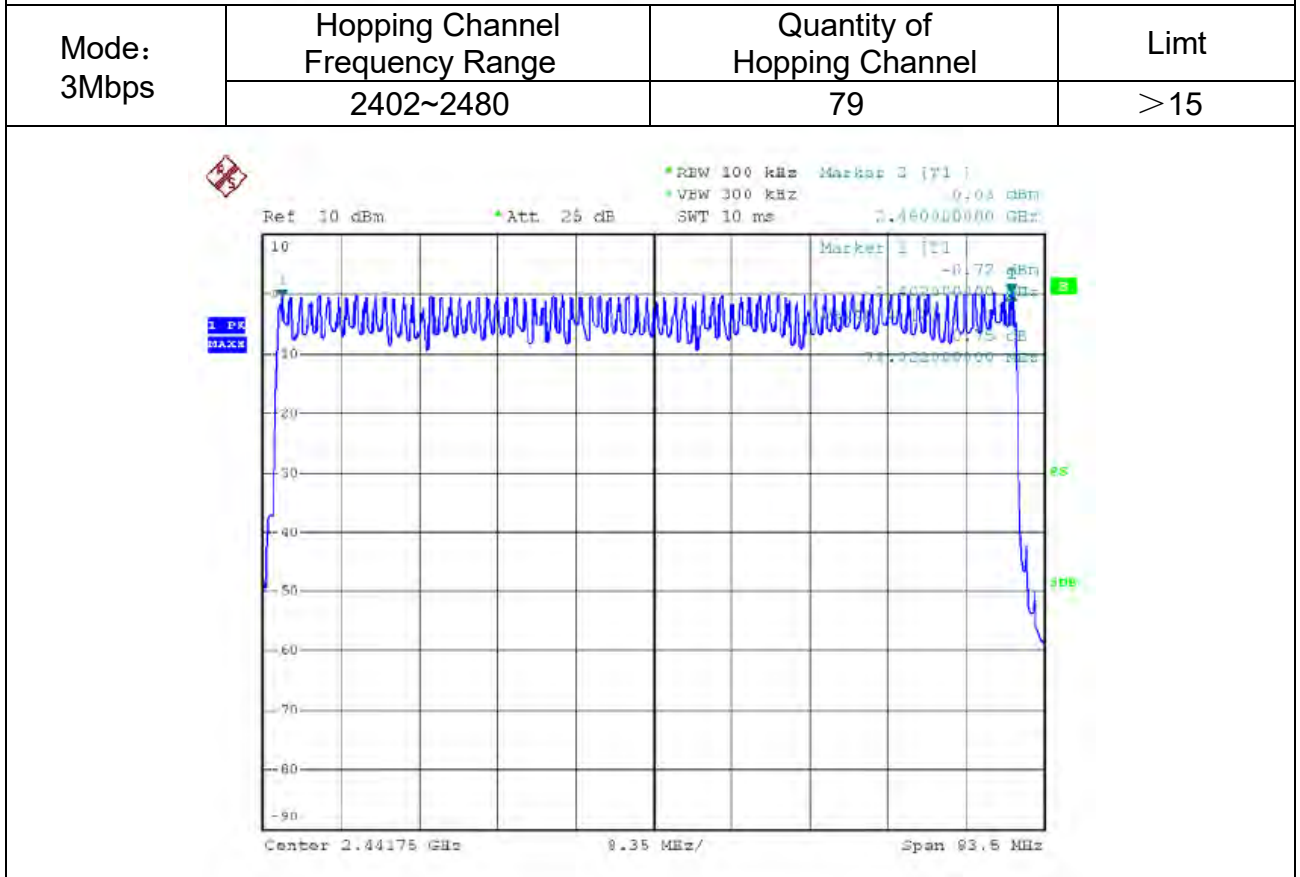
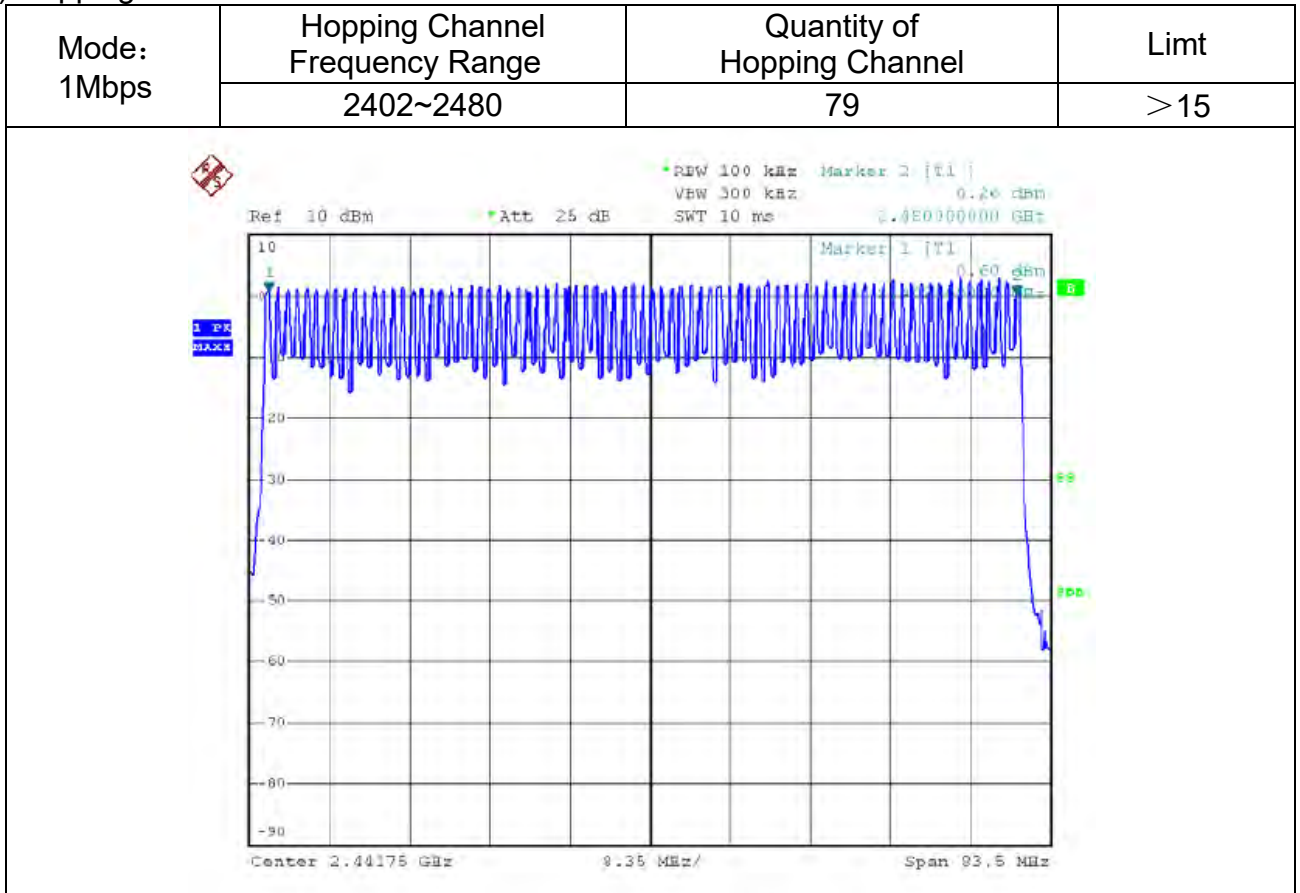

6 Hopping Frequency Separation

6.1 Test Standard and Limit

6.1.1 Test Standard

ETSI EN 300 328 V2.1.1: 2016 clause 4.3.1.4

6.1.2 Limits

Test Item	Frequency Range (MHz)	Limit	Result
Hopping Channel Separation(Non-adaptive)	2400-2483.5	Occupied Channel Bandwidth or 100 kHz which is greater	PASS
Hopping Channel Separation(Adaptive)		100 kHz	PASS

6.2 Test Setup

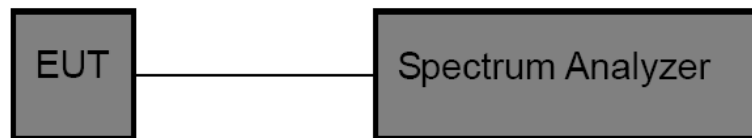

6.3 Test Procedure

1. The transmitter output was connected to the spectrum analyzer.
2. Set the spectrum analyzer as follows to measure the 20 dB bandwidth.
 - Resolution BW : 30 kHz
 - Resolution BW :100 kHz
 - Detector : Peak
 - Trace Mode : Max Hold.
 - Sweep time : Auto.
 - Span : Wide enough to capture the channel separation
3. Set the spectrum analyzer as follows to measure the 20 dB bandwidth.
 - Resolution BW : 30 kHz
 - Resolution BW :100 kHz
 - Detector : Peak
 - Trace Mode : Max Hold
 - Sweep time : Auto
 - Span : Wide enough to capture the channel separation

6.4 Test Equipment Used

Description	Manufacturer	Model No.	Serial No.	Last Cal.	Cal. Interval
Spectrum Analyzer	ROHDE&SCHWARZ	FSEA20	DE25181	2019-01-02	1 Year
DC power supply	GVE	PL0825	N/A	N/A	N/A

6.5 Test Data

EUT:	Bluetooth Speaker	Model Name :	DSBT048
Temperature:	23°C	Relative Humidity :	60%
Pressure:	1010 hPa	Test Voltage :	DC3.7V
Test Mode:	2402MHz/2441MHz/2480MHz 1Mbps		

Ch. Separation Limit : >99% OBW or 100 kHz

Frequency (MHz)	Ch. Separation (MHz)	99% Occupied Bandwidth (kHz)	Result
2402	1.014	840	PASS
2441	0.996	840	PASS
2480	1.002	834	PASS

2402 MHz Channel Separation

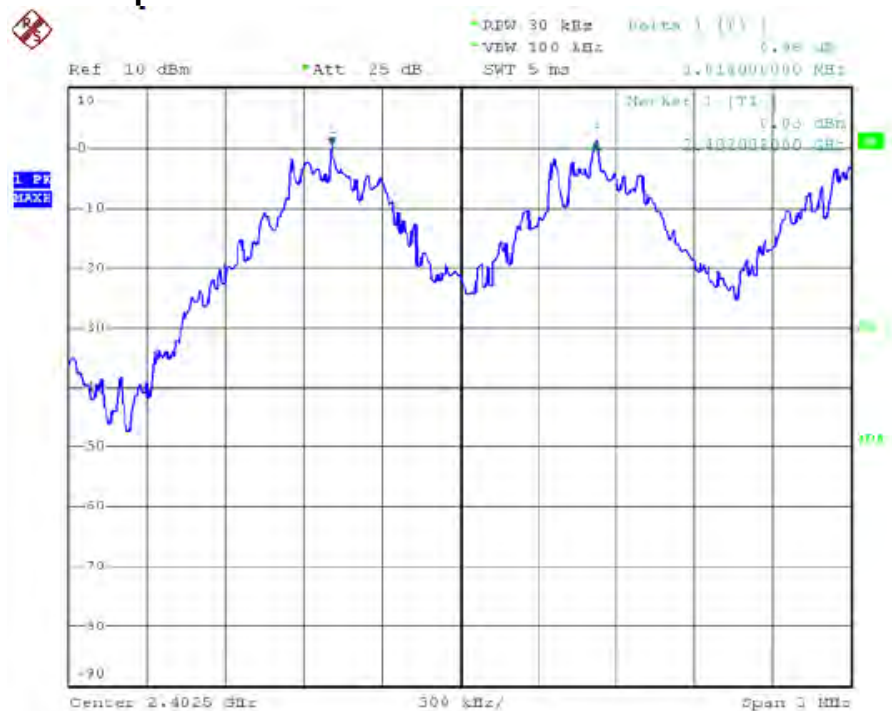

2441 MHz Channel Separation

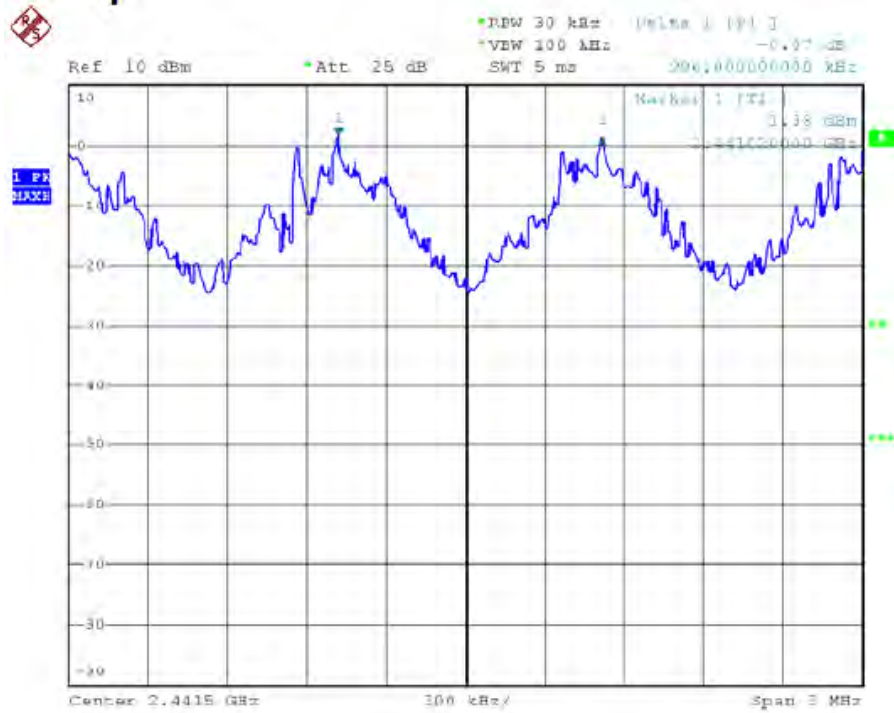

2480 MHz Channel Separation

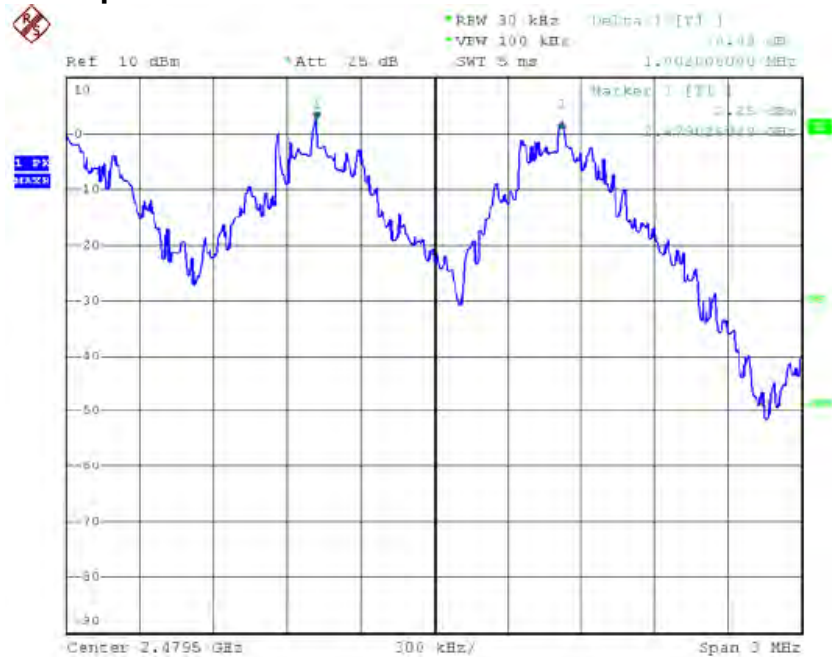

EUT:	Bluetooth Speaker	Model Name :	DSBT048
Temperature:	23°C	Relative Humidity :	60%
Pressure:	1010 hPa	Test Voltage :	DC3.7V
Test Mode:	2402MHz/2441MHz/2480MHz 3Mbps		

Ch. Separation Limit : >99% OBW or 100 kHz

Frequency (MHz)	Ch. Separation (MHz)	99% Occupied Bandwidth (kHz)	Result
2402	1.008	1152	PASS
2441	1.002	1152	PASS
2480	1.026	1146	PASS

2402 MHz Channel Separation

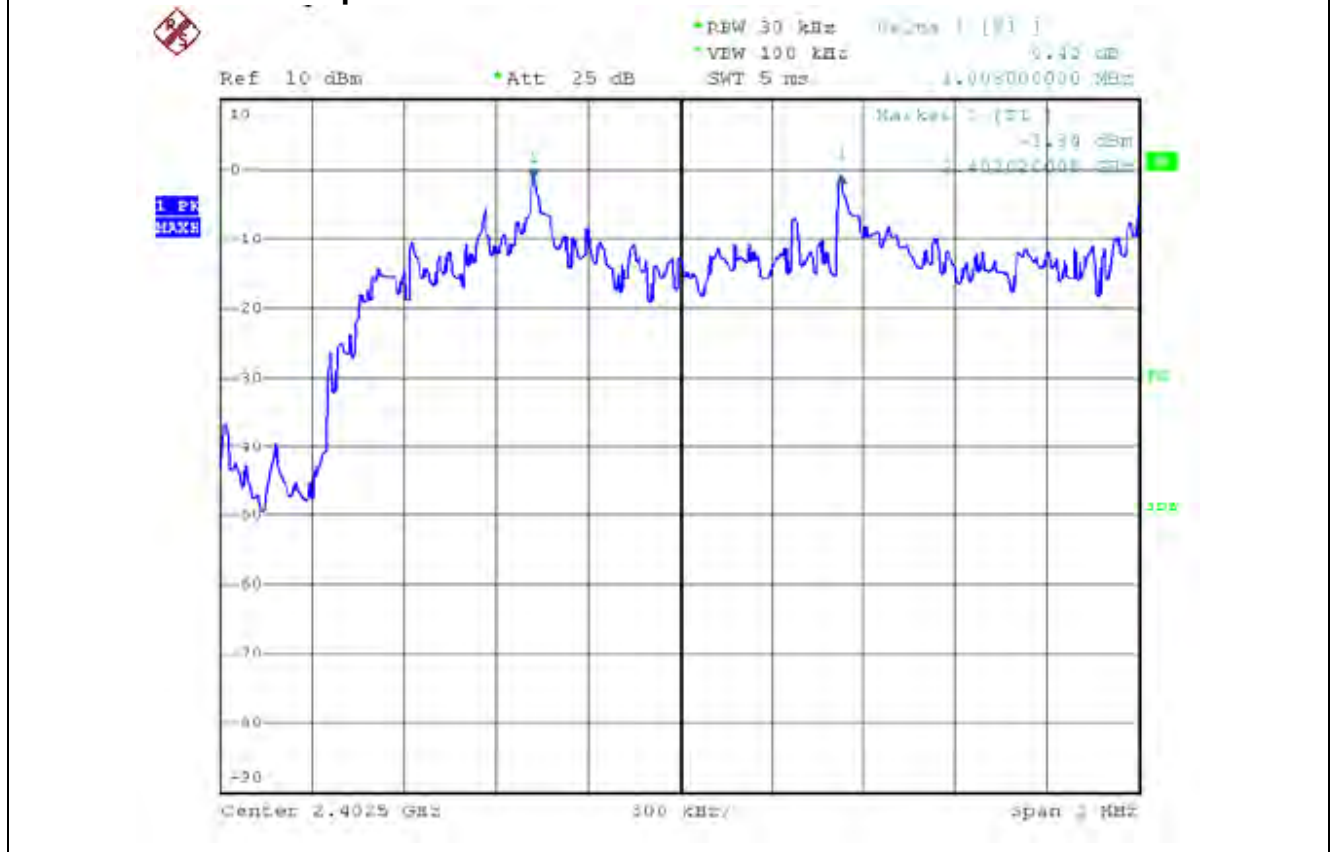

2441 MHz Channel Separation

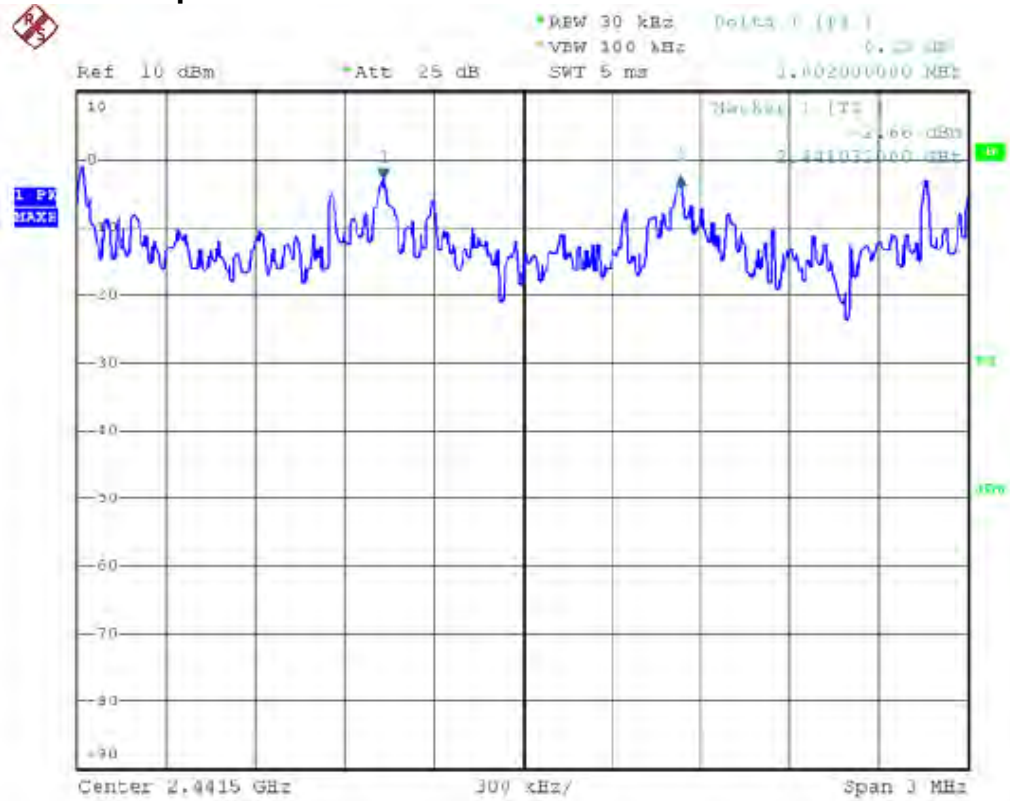

2480 MHz Channel Separation

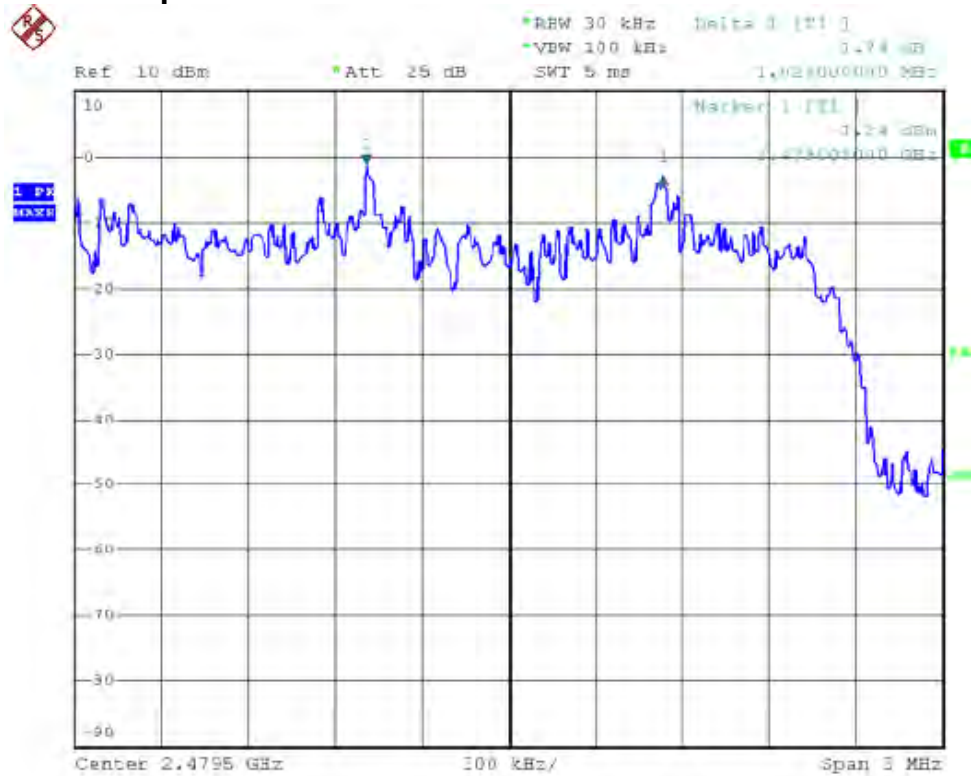

7 Occupied Channel Bandwidth

7.1 Test Standard and Limit

7.1.1 Test Standard

ETSI EN 300 328 V2.1.1: 2016 clause 4.3.1.7

7.1.2 Limits

Test Item	Frequency Range (MHz)	Limit	Result
Occupied Bandwidth	2400-2483.5	Fall completely within the Operation Band	PASS
		For non-adaptive Frequency Hopping equipment with e.i.r.p greater than 10 dBm, the occupied Bandwidth shall equal to or less than the value declared by the supplier, and shall not greater than 5 MHz.	

7.2 Test Setup

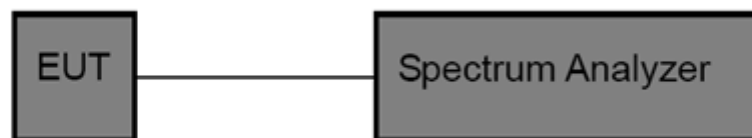

7.3 Test Procedure

- The transmitter output was connected to the spectrum analyzer.
- Set the spectrum analyzer as follows to measure the 20 dB bandwidth.
 - Resolution BW : 30kHz.
 - Resolution BW :100kHz.
 - Detector : Peak.
 - Trace Mode : Max Hold.
 - Sweep time : Auto.
 - Span : Wide enough to capture the channel separation.
- Set the spectrum analyzer as follows to measure the 20 dB bandwidth.
 - Resolution BW : 30kHz.
 - Resolution BW :100kHz.
 - Detector : Peak.
 - Trace Mode : Max Hold.
 - Sweep time : Auto.
 - Span :3MHz

7.4 Test Equipment Used

Description	Manufacturer	Model No.	Serial No.	Last Cal.	Cal. Interval
Spectrum Analyzer	ROHDE&SCHWARZ	FSEA20	DE25181	2019-01-02	1 Year
DC power supply	GVE	PL0825	N/A	N/A	N/A

7.5 Test Data

EUT:	Bluetooth Speaker	Model Name :	DSBT048
Temperature:	23°C	Relative Humidity :	60%
Pressure:	1010 hPa	Test Voltage :	DC 3.7 V
Test Mode:	2402/2441/2480MHz 1Mbps		
Fall completely within the Operation Band			
Frequency (MHz)	20dB Bandwidth (kHz)	99%Occupied Bandwidth (kHz)	Result
2402	828.00	840.00	Pass
2441	846.00	834.00	Pass
2480	846.00	834.00	Pass

2402 MHz Bandwidth

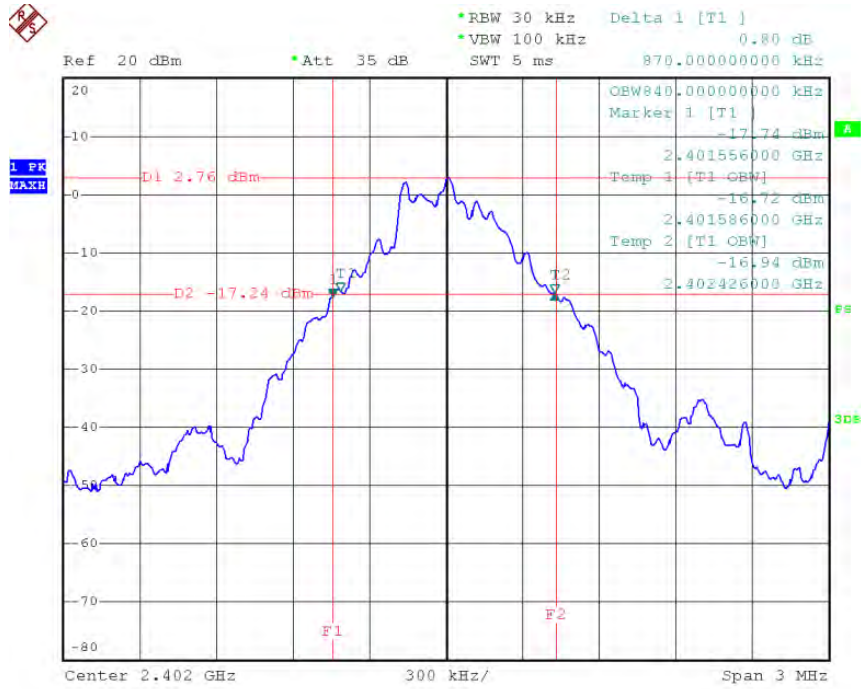

2441 MHz Bandwidth

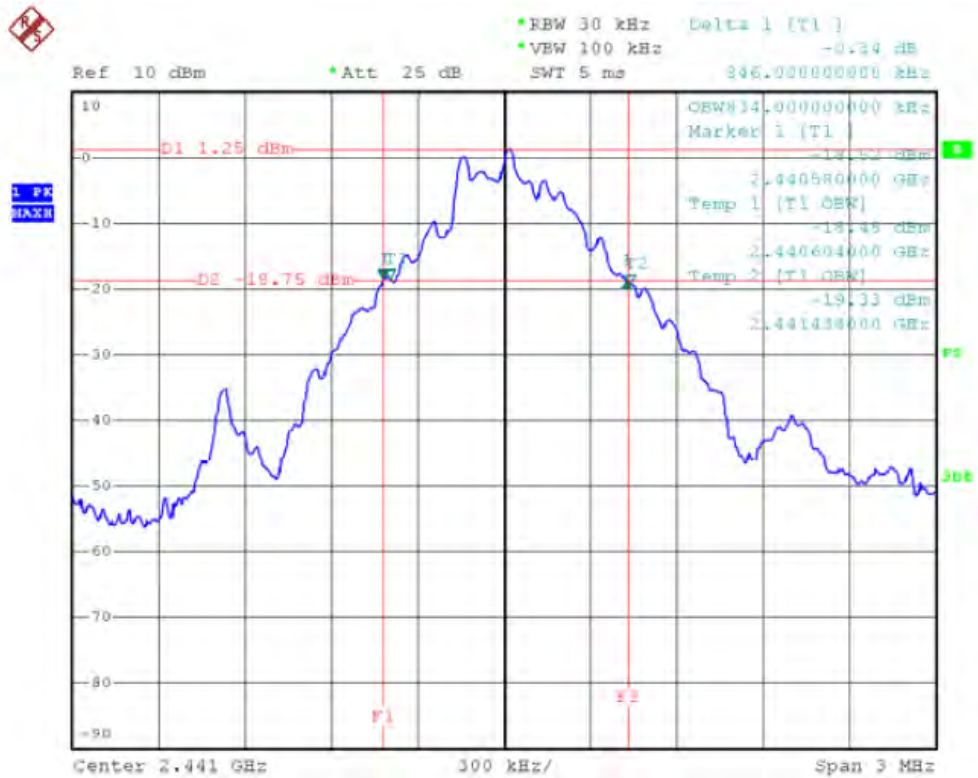

2480 MHz Bandwidth

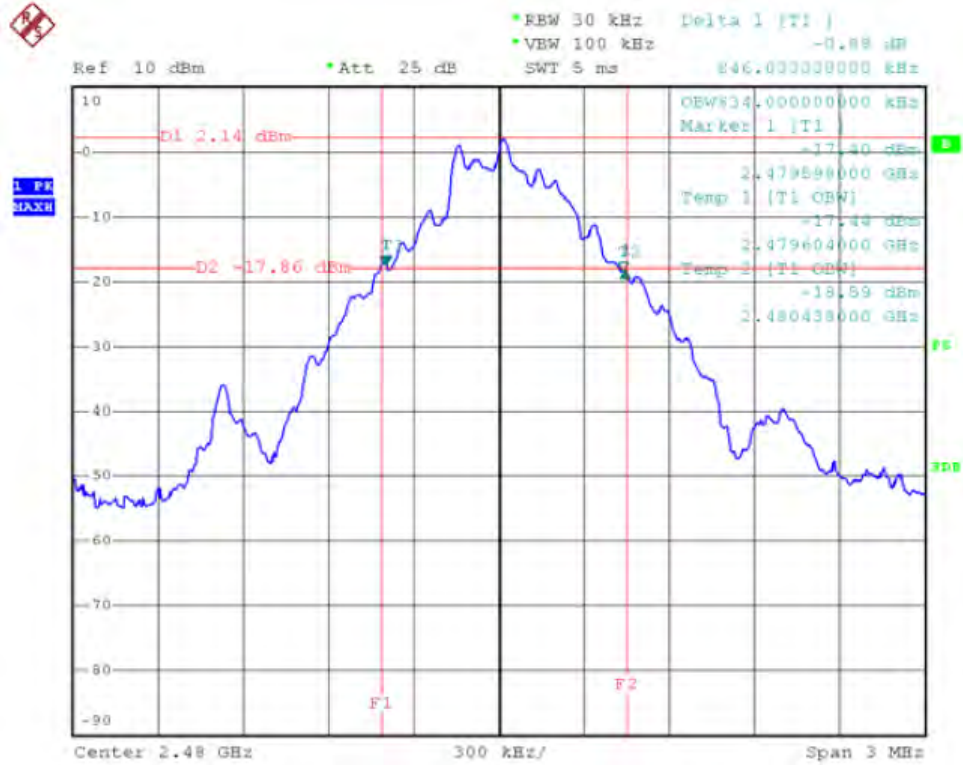

EUT:	Bluetooth Speaker	Model Name :	DSBT048
Temperature:	23°C	Relative Humidity :	60%
Pressure:	1010 hPa	Test Voltage :	DC 3.7 V
Test Mode:	2402/2441/2480MHz 3 Mbps		
Fall completely within the Operation Band			
Frequency (MHz)	20dB Bandwidth (kHz)	99%Occupied Bandwidth (kHz)	Result
2402	1206.00	1152.00	Pass
2441	1212.00	1152.00	Pass
2480	1206.00	1146.00	Pass

2402 MHz Bandwidth

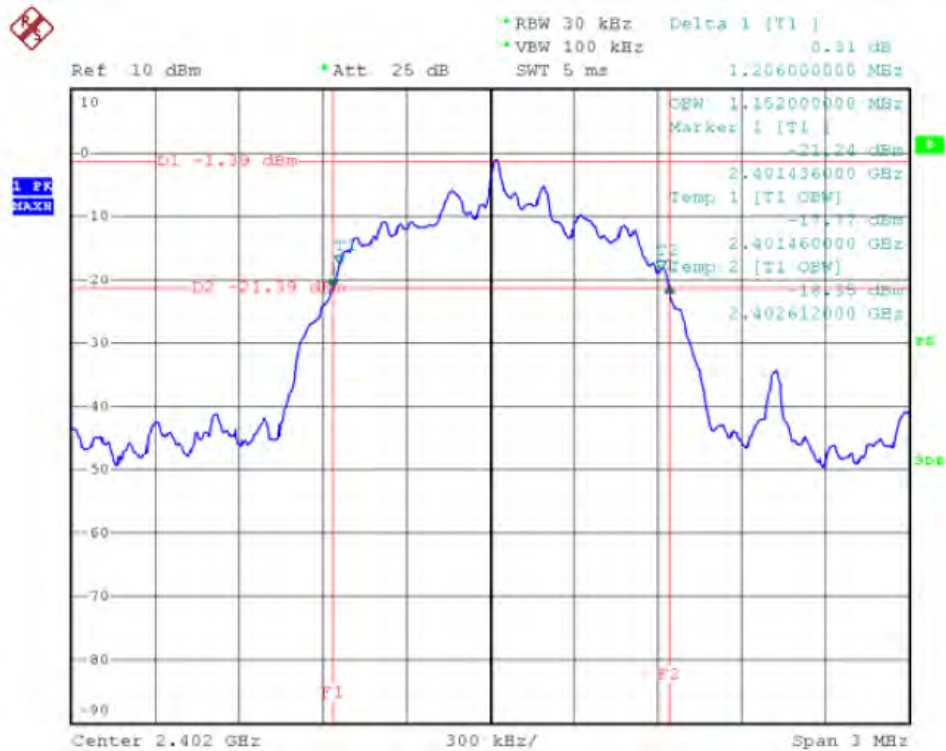

2441 MHz Bandwidth

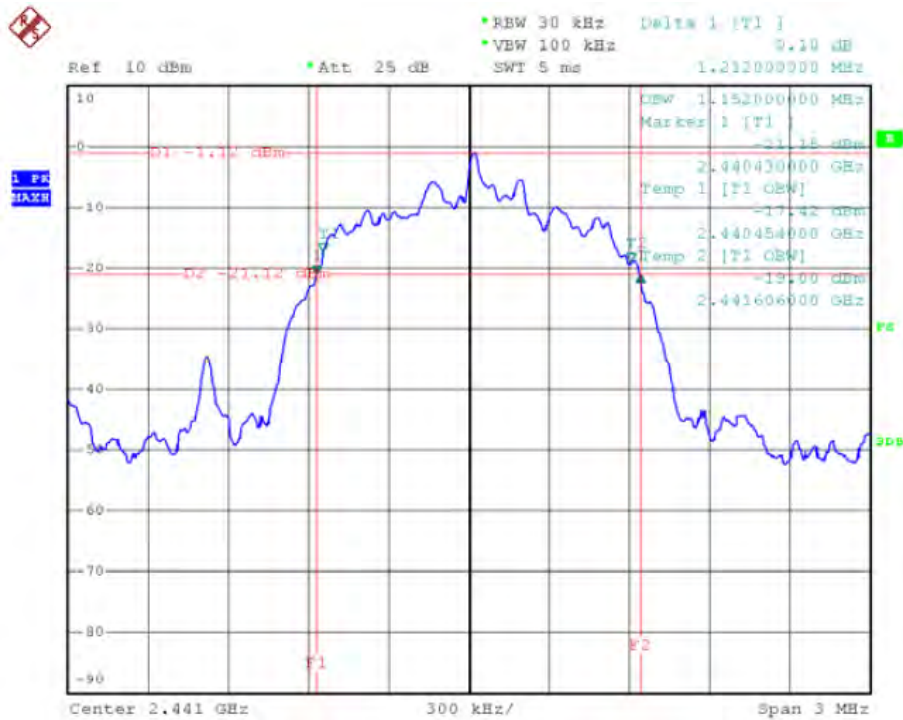

2480 MHz Bandwidth

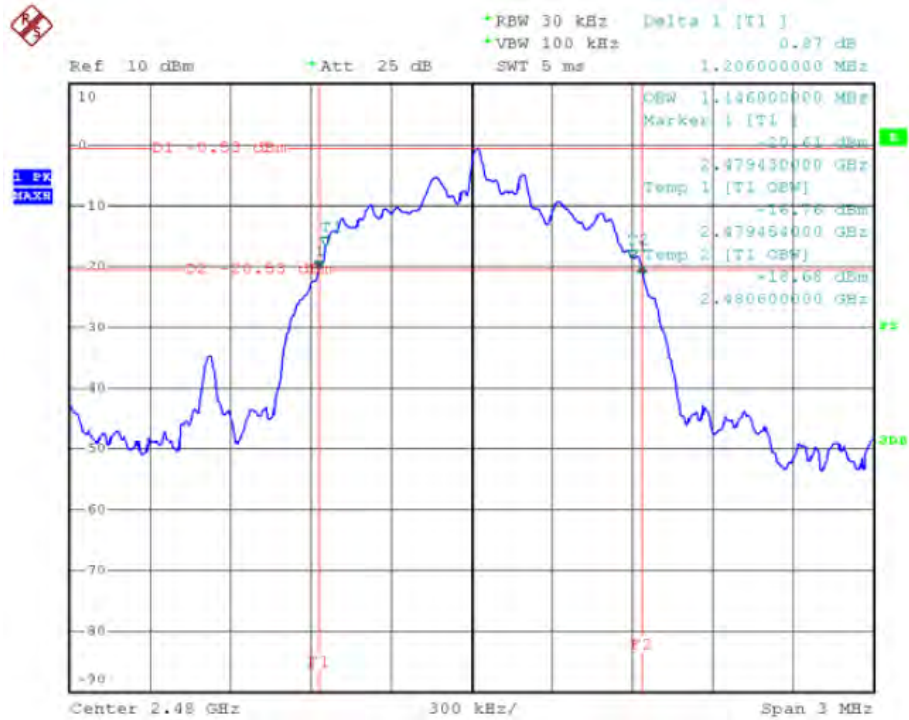

8 Medium Utilisation (MU) factor

8.1 Test Standard and Limit

8.1.1 Test Standard

ETSI EN 300 328 V2.1.1: 2016 clause 4.3.1.5

8.1.2 Limits

Transmitter limits for narrowband spurious emissions

Test Item Limit	Limit
Medium Utilisation Factor	Less than 10%

8.2 Test Setup

This requirement does not apply to adaptive equipment unless operating in non-adaptive mode.

In addition, this requirement does not apply for equipment with a maximum declared RF Output power level of less than 10 dBm e.i.r.p. for equipment when operating in a mode where the RF Output power is less than 10 dBm e.i.r.p.

The Equipment e.i.r.p. power is less than 10 dBm, So no requirement for this test item.

9 Adaptivity (Adaptive Frequency Hopping)

9.1 Test Standard and Limit

9.1.1 Test Standard

ETSI EN 300 328 V2.1.1: 2016 clause 4.3.1.6

9.1.2 Test Description

Adaptive Frequency Hopping equipment is allowed to operate in a non-adaptive mode providing it complies with the requirements applicable to non-adaptive frequency hopping equipment.

Adaptive Frequency Hopping equipment is allowed to have Short Control Signaling Transmissions (e.g. ACK/NACK signals, etc.) without sensing the frequency for the presence of other signals. Please see clause 4.3.1.6.3 Short Control Signaling Transmissions

Adaptive Frequency Hopping (AFH) equipment uses a Detect And Avoid (DAA) mechanism which allows an equipment to adapt to its environment by identifying frequencies, that are being used by other equipment.

Adaptive frequency Hopping systems shall implement either of the DAA mechanisms provided in clauses 4.3.1.6.1 Adaptive Frequency Hopping Using LBT based DAA or 4.3.1.6.2 Adaptive Frequency Hopping Using other forms of DAA (non-LBT based)

9.2 Test Setup

This requirement does not apply to non-adaptive equipment or adaptive equipment operating in a non-adaptive mode providing the equipment complies with the requirements and /or restrictions applicable to non-adaptive equipment.

In addition, this requirement does not apply for equipment with a maximum declared RF Output power level of less than 10 dBm e.i.r.p. for equipment when operating in a mode where the RF Output power is less than 10 dBm e.i.r.p.

Note:

The Equipment e.i.r.p. power is less than 10 dBm, so no requirement for this test item.

10 Transmitter Unwanted Emissions in the out-of-band domain

10.1 Test Standard and Limit

10.1.1 Test Standard

ETSI EN 300 328 V2.1.1: 2016 clause 4.3.1.8

10.1.2 Limits

The transmitter unwanted emissions in the out-of-band domain but outside the allocated band, shall not exceed the values provided by the mask in figure 1 of clause 4.3.1.8.2

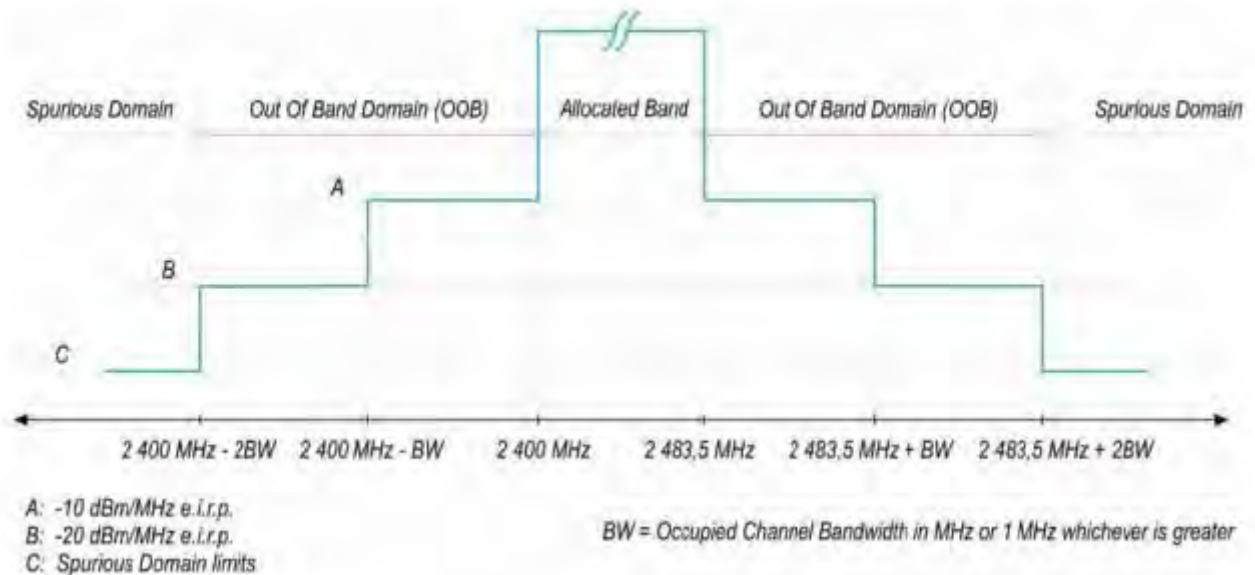

Adaptive Frequency Hopping equipment is allowed to operate in a non-adaptive mode

10.2 Test Setup

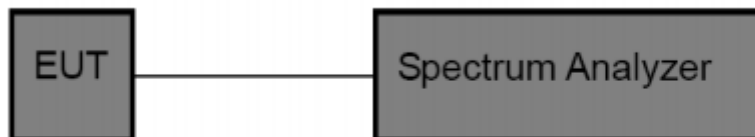

10.3 Test Procedure

(1) The transmitter output was connected to the spectrum analyzer.

Set the spectrum analyzer as following:

Centre Frequency: 2484 MHz.

Span: 0 Hz

Resolution BW : 1 MHz

Filter mode: Channel filter

Video BW : 3 MHz
 Detector Mode: RMS
 Trace Mode : Clear / Write
 Sweep Mode: Continuous
 Sweep Points : 5000
 Trigger Mode: Video trigger
 Sweep Time: Suitable to capture one transmission burst

Step 2 (2483.5 MHz to 2483.5 MHz +BW):

- (1) Adjust trigger level to select the transmissions with the highest power level.
- (2) The highest power level shall be selected.
- (3) Set a window to match with the start and end of the burst and in which the RMS Power shall be measured using the Time Domain Power Function.
- (4) RMS Power within this 1 MHz segment (2483.5 MHz to 2484.5 MHz). Compare this value

the applicable limit provided by the mask.

- (5) Increase the centre frequency in steps of 1 MHz and repeat this measurement for every 1

1 MHz segment within the range 2483.5 MHz to 2483.5 MHz+BW. The centre frequency of the last 1 MHz segment within the range 2483.5 MHz to 2483.5 MHz +BW. The centre frequency of the last 1 MHz segment shall be set to 2483.5 MHz+BW-0.5 MHz (which means this may partly overlap with the previous 1 MHz segment).

Step 3 (2483.5 MHz +BW to 2483.5 MHz +2BW):

- (1) Change the centre frequency of the analyzer to 2484MHz + BW and perform the measurement for the first 1MHz segment within range 2483.5MHz +BW to 2483.5 MHz +2BW. Increase the centre frequency in 1MHz steps and repeat the measurements to cover this whole range. The centre frequency of the last 1 MHz segment shall be set to 2483.5 MHz+ 2BW-0.5 MHz.

Step 4 (2400 MHz-BW to 2400 MHz):

- (1) Change the centre frequency of the analyzer to 2399.5MHz and perform the measurement for the first 1MHz segment within range 2400 MHz -BW to 2400 MHz Reduce the centre frequency in 1MHz steps and repeat the measurement to cover this whole range. The centre frequency of the last 1 MHz segment shall be set to 2400 MHz -BW+ 0.5 MHz.

Step 5 (2400 MHz-BW to 2400 MHz):

- (1) Change the centre frequency of the analyzer to 2399.5MHz-BW and perform the measurement for the first 1MHz segment within range 2400 MHz -2BW to 2400 MHz +CBW. Reduce the centre frequency in 1MHz steps and repeat the measurement to cover this whole range. The centre frequency of the last 1 MHz segment shall be set to 2400 MHz -2BW+ 0.5 MHz.

10.4 Test Equipment Used

Description	Manufacturer	Model No.	Serial No.	Last Cal.	Cal. Interval
Spectrum Analyzer	ROHDE& SCHWARZ	FSP30	DE25181	2019-01-02	1 Year
DC Power	GVE	PL0825	N/A	N/A	N/A

10.5 Test Date

EUT:	Bluetooth Speaker	Model:	DSBT048	
Temperature:	23°C	Relative Humidity :	60%	
Pressure:	1010 hPa	Test Voltage :	AC 230V/50HZ	
Test Mode: Normal Hopping Mode (GFSK)				
Frequency Band		Maximum Level	Limit	Result
(2483.5MHz,2483.5MHz+BW)		-47.56	-10dBm/MHz	Pass
(2483.5MHz+BW,2483.5MHz+BW)		-49.37	-20dBm/MHz	Pass
(2400MHz-BW,2400MHz)		-46.52	-10dBm/MHz	Pass
(2400MHz-2BW,2400MHz-BW)		-49.67	-20dBm/MHz	Pass
Test Mode: Normal Hopping Mode (8-DPSK)				
(2483.5MHz,2483.5MHz+BW)		-46.55	-10dBm/MHz	Pass
(2483.5MHz+BW,2483.5MHz+BW)		-48.36	-20dBm/MHz	Pass
(2400MHz-BW,2400MHz)		-46.47	-10dBm/MHz	Pass
(2400MHz-2BW,2400MHz-BW)		-47.83	-20dBm/MHz	Pass

THIS DOCUMENT WAS REDACTED WITH THE PRODUCTIP REDACTION TOOL ON 2019-08-28. AT THE TIME OF GENERATING THE DOCUMENT THE ORIGINAL DOCUMENT WAS AVAILABLE ALSO. THE ORIGINAL CAN ONLY BE MADE AVAILABLE BY THE DOCUMENT OWNER.

11 TRANSMITTER UNWANTED SPURIOUS EMISSIONS IN THE SPURIOUS DOMAIN

11.1 Test Standard and Limit

11.1.1 Test Standard

ETSI EN 300 328 V2.1.1: 2016 clause 4.3.2.8

11.1.2 Limits

Transmitter limits for spurious emissions

Frequency Range	Maximum Power, e.r.p.(≤ 1 GHz) e.i.r.p.(> 1 GHz)	Bandwidth
30 MHz to 47 MHz	-36 dBm	100 kHz
47 MHz to 74 MHz	-54 dBm	100 kHz
74 MHz to 87.5 MHz	-36 dBm	100 kHz
87.5 MHz to 118 MHz	-54 dBm	100 kHz
118 MHz to 174 MHz	-36 dBm	100 kHz
174 MHz to 230 MHz	-54 dBm	100 kHz
230 MHz to 470 MHz	-36 dBm	100 kHz
470 MHz to 862 MHz	-54 dBm	100 kHz
862 MHz to 1 GHz	-36 dBm	100 kHz
Above 1 GHz to 12.75 GHz	-30 dBm	1 MHz

11.2 Test Setup

(A) Radiated Emission Test Set-Up Frequency Bellow 1 GHz.

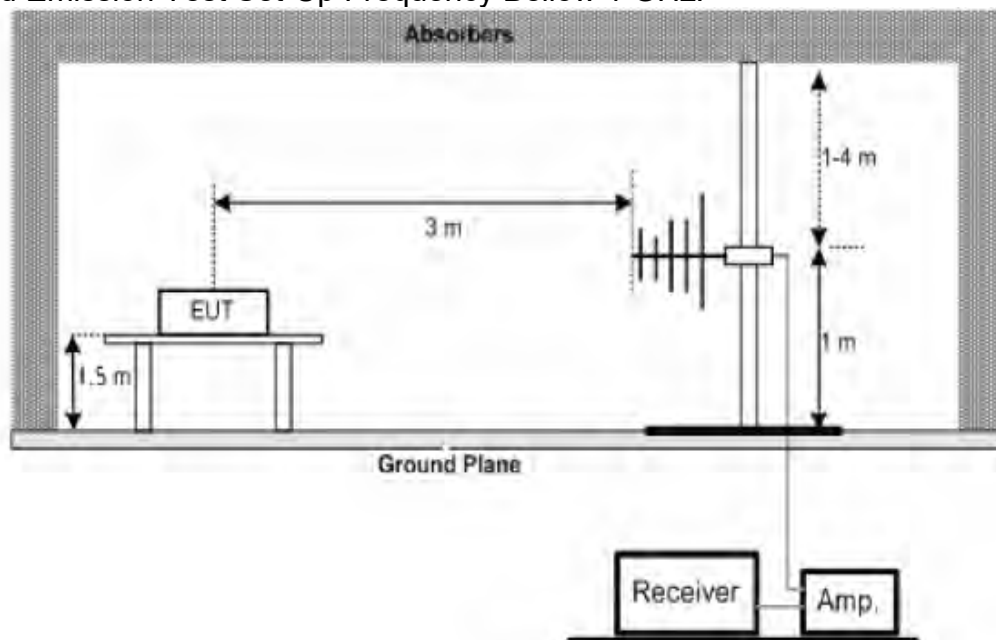

(B) Radiated Emission Test Set-Up Frequency Above 1 GHz.

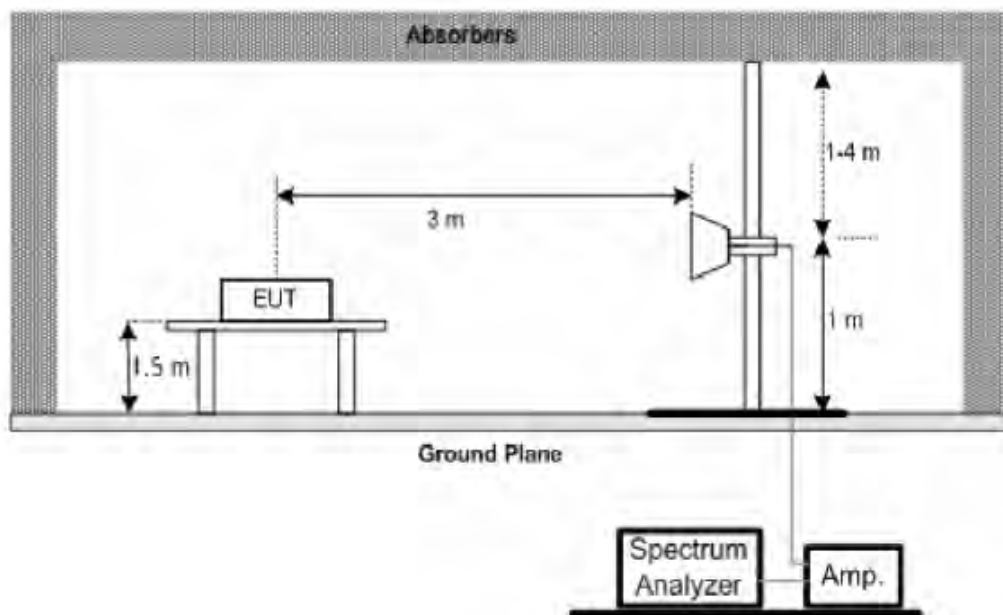

11.3 Test Procedure

1. The EUT was placed on the top of the turntable in chamber.
2. The test shall be made in the transmitting mode. The turntable was rotated by 360 degrees to determine the position of the highest radiation.
3. Set the spectrum analyzer as follows to measure the emissions (Below 1 GHz):
 - Resolution BW : 100 kHz.
 - Resolution BW : 300 kHz.
 - Detector : RMS.
 - Trace Mode : Max Hold.
 - Sweep time : 1s.
 - Span : 100M.
 - Amplitude : Adjust for middle of the instrument's range.
4. Set the spectrum analyzer as follows to measure the emissions (Above 1 GHz):
 - Resolution BW : 1 MHz.
 - Resolution BW : 3 MHz.
 - Detector : RMS.
 - Trace Mode : Max Hold.
 - Sweep time : 1s.
 - Span : 100M.
 - Amplitude : Adjust for middle of the instrument's range.
5. For 30~1000MHz spurious emissions antenna was placed 3 meters far away from the turntable. .
6. The broadband receiving antenna was fixed on each suspected emissions of both horizontal suspected value is indicated as Read Level (Raw).
7. Replace the EUT by standard antenna and feed the RF port by signal generator.
8. Adjust the frequency of the signal generator to the suspected emission and slightly rotate the turntable to locate the position with maximum reading.
9. Adjust the power level of the signal generator to reach the same reading with Read Level

(Raw).

10. The level of the spurious emission is the power level of (g) plus the gain of the standard antenna in dBi and minus the loss of the cable used between the signal generator and the standard antenna.

11. If the measuring emissions that exceed the level of 6 dB below the applicable limit, the resolution bandwidth shall be switched to 30 kHz and the span shall be adjusted accordingly. If the level does not change by more than 2 dB, it is a narrowband emission; the observed value shall be recorded. If the level changes by more than 2 dB, the emission is a wideband emission and its level shall be measured and recorded.

12. The measurement shall be repeated at the lowest and the highest channel of the stated frequency range.

11.4 Test Equipment Used

Description	Manufacturer	Model No.	Serial No.	Last Cal.	Cal. Interval
Spectrum Analyzer	ROHDE& SCHWARZ	FSEA20	DE25181	2019-01-02	1 Year
Spectrum Analyzer	Agilent	E4407B	MY49510055	2019-01-02	1 Year
EMI Receiver	ROHDE& SCHWARZ	ESCI	101165	2019-01-02	1 Year
Bilog Antenna	SCHWARZBECK	VULB9168	9120-426	2019-01-02	1 Year
Horn Antenna	SCHWARZBECK	BBHA9120 D	SW060023	2019-01-02	1 Year
Horn Antenna	SCHWARZBECK	BBHA9120	BBHA9170D	2019-01-02	1 Year
Active Loop Antenna	Beijing Daze	ZN30900A	SEL0097	2019-01-02	1 Year
Pre-amplifier	SCHWARZBECK	BBV9743	9743-019	2019-01-02	1 Year
Pre-amplifier	Quietek	AP-180C	CHM-060212	2019-01-02	1 Year
Signal Generator	ROHDE& SCHWARZ	SML03	T0054	2019-01-02	1 Year
Temp. & Humid. Chamber	GIANT	IHT-550	IKW682-054	2019-01-02	1 Year

11.5 Test Date

(1) Bellow 1 G

EUT:	Bluetooth Speaker	Model Name :	DSBT048
Temperature:	23°C	Relative Humidity:	60%
Pressure:	1010 hPa	Test Voltage :	DC3.7V
Test Mode :	TX 2402MHz 1Mbps		

Frequency (MHz)	Ant H / V	TX/RX	Measured (dBm)	Limits (dBm)	Margins	Note
99.4100	V	TX	-67.25	-54.00	13.25	
142.0200	V	TX	-69.45	-36.00	33.45	
165.2500	V	TX	-70.15	-36.00	34.15	
259.5800	V	TX	-70.44	-36.00	34.44	
443.0500	V	TX	-68.58	-36.00	32.58	

57.2600	H	TX	-71.77	-54.00	17.87	
185.3000	H	TX	-69.31	-54.00	15.41	
408.4000	H	TX	-67.45	-36.00	31.55	
551.9600	H	TX	-63.97	-54.00	10.07	
600.4600	H	TX	-65.24	-54.00	11.34	
745.9600	H	TX	-64.72	-54.00	10.82	

(2) Above 1 G

EUT:	Bluetooth Speaker	Model Name :	DSBT048
Temperature:	23°C	Relative Humidity:	60%
Pressure:	1010 hPa	Test Voltage :	DC3.7V
Test Mode :	TX 2402MHz 1Mbps		

Frequency (MHz)	Ant H / V	TX/RX	Measured (dBm)	Limits (dBm)	Margins	Note
4804.0700	V	TX	-35.74	-30.00	5.74	
---	V	TX	---	---	---	
---	V	TX	---	---	---	

4804.0700	H	TX	-33.54	-30.00	3.54	
---	H	TX	---	---	---	
---	H	TX	---	---	---	

EUT:	Bluetooth Speaker	Model Name :	DSBT048
Temperature:	23°C	Relative Humidity:	60%
Pressure:	1010 hPa	Test Voltage :	DC3.7V
Test Mode :	TX 2480MHz 1Mbps		

Frequency (MHz)	Ant H / V	TX/RX	Measured (dBm)	Limits (dBm)	Margins	Note
4960.0400	V	TX	-38.47	-30.00	8.47	
---	V	TX	---	---	---	
---	V	TX	---	---	---	

4960.0400	H	TX	-36.18	-30.00	6.18	
---	H	TX	---	---	---	
---	H	TX	---	---	---	

EUT:	Bluetooth Speaker	Model Name :	DSBT048
Temperature:	23°C	Relative Humidity:	60%
Pressure:	1010 hPa	Test Voltage :	DC3.7V
Test Mode :	TX 2402MHz 3Mbps		

Frequency (MHz)	Ant H / V	TX/RX	Measured (dBm)	Limits (dBm)	Margins	Note
4804.2700	V	TX	-41.13	-30.00	11.13	
---	V	TX	---	---	---	
---	V	TX	---	---	---	

4804.2400	H	TX	-43.29	-30.00	13.29	
---	H	TX	---	---	---	
---	H	TX	---	---	---	

EUT:	Bluetooth Speaker	Model Name :	DSBT048
Temperature:	23°C	Relative Humidity:	60%
Pressure:	1010 hPa	Test Voltage :	DC3.7V
Test Mode :	TX 2480 MHz 3Mbps		

Frequency (MHz)	Ant H / V	TX/RX	Measured (dBm)	Limits (dBm)	Margins	Note
5190.2000	V	TX	-36.96	-30.00	6.96	
---	V	TX	---	---	---	
---	V	TX	---	---	---	

5190.2000	H	TX	-36.85	-30.00	6.85	
---	H	TX	---	---	---	
---	H	TX	---	---	---	

12 Receiver Spurious Emissions

12.1 Test Standard and Limit

12.1.1 Test Standard

ETSI EN 300 328 V2.1.1: 2016 clause 4.3.1.10

12.1.2 Limits

Spurious emission limits for receivers

Frequency Range	Maximum Power, e.r.p.(≤ 1 GHz) e.i.r.p.(> 1 GHz)	Bandwidth
30 MHz to 1 GHz	-57 dBm	100 kHz
1 GHz to 12.75 GHz	-47 dBm	1 MHz

12.2 Test Setup

(A) Radiated Emission Test Set-Up Frequency Bellow 1 GHz.

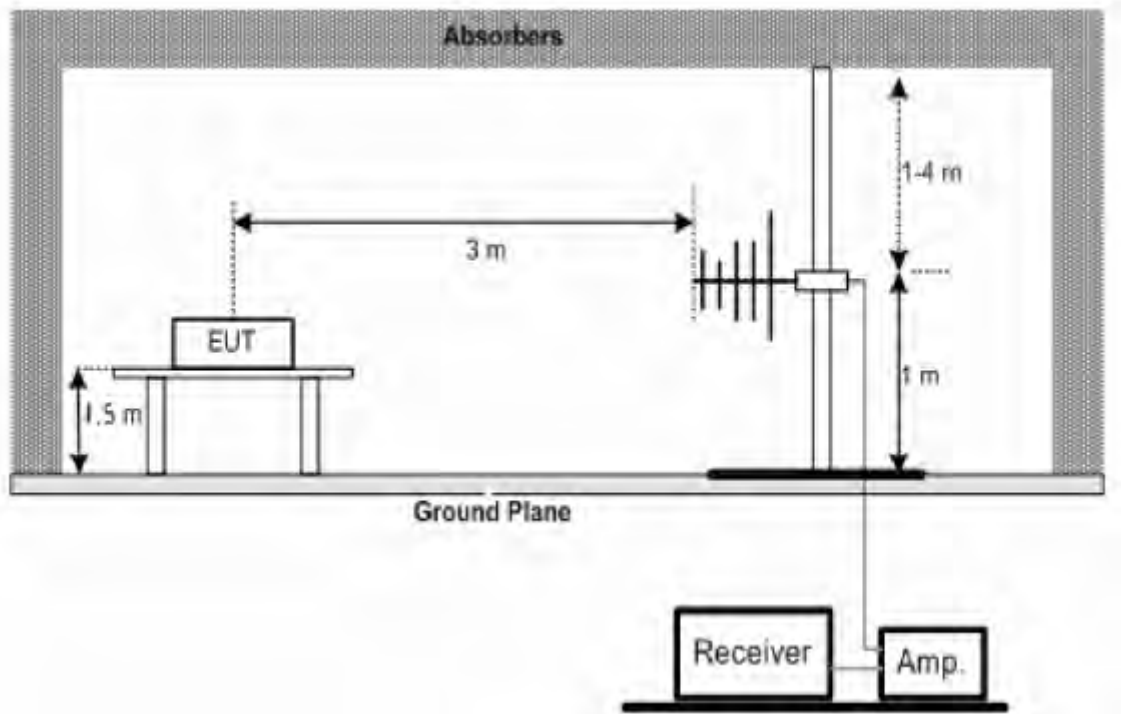

(B) Radiated Emission Test Set-Up Frequency Above 1 GHz.

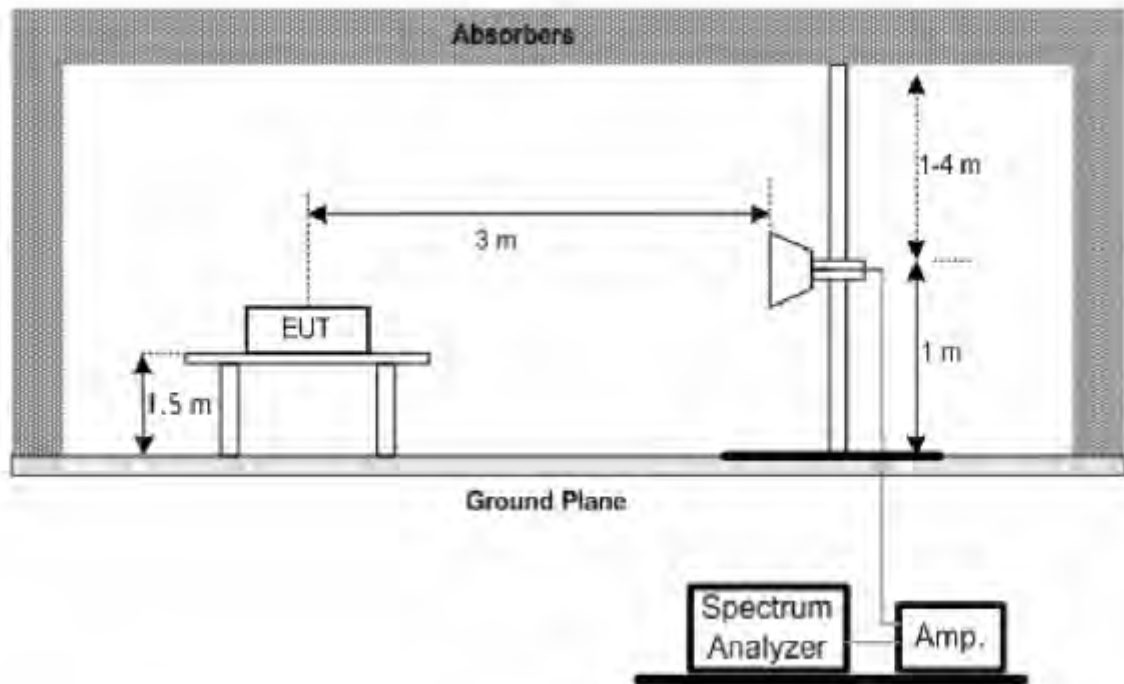

12.3 Test Procedure

1. The EUT was placed on the top of the turntable in chamber.
2. The test shall be made in the transmitting mode. The turntable was rotated by 360 degrees to determine the position of the highest radiation.
3. Set the spectrum analyzer as follows to measure the emissions:
 - Resolution BW : 100 kHz.
 - Resolution BW : 300 kHz.
 - Detector : RMS.
 - Trace Mode : Max Hold.
 - Sweep time : 1s.
 - Span : 100M.
 - Amplitude : Adjust for middle of the instrument's range.
4. Set the spectrum analyzer as follows to measure the emissions:
 - Resolution BW : 1 MHz.
 - Resolution BW : 3 MHz.
 - Detector : RMS.
 - Trace Mode : Max Hold.
 - Sweep time : 1s.
 - Span : 100M.
 - Amplitude : Adjust for middle of the instrument's range.
5. For 30~1000MHz spurious emissions measurement, the broad band bi-log receiving antenna was placed 3 meters far away from the turntable. .
6. The broadband receiving antenna was fixed on the same height with the EUT to find each suspected emissions of both horizontal and vertical polarization. Each recorded suspected value is indicated as Read Level (Raw).

7. Replace the EUT by standard antenna and feed the RF port by signal generator.
8. Adjust the frequency of the signal generator to the suspected emission and slightly rotate the turntable to locate the position with maximum reading.
9. Adjust the power level of the signal generator to reach the same reading with Read Level (Raw).
10. The level of the spurious emission is the power level of (g) plus the gain of the standard antenna in dBi and minus the loss of the cable used between the signal generator and the standard antenna.
11. If the measuring emissions that exceed the level of 6 dB below the applicable limit, the resolution bandwidth shall be switched to 30 kHz and the span shall be adjusted accordingly. If the level does not change by more than 2 dB, it is a narrowband emission; the observed value shall be recorded. If the level changes by more than 2 dB, the emission is a wideband emission and its level shall be measured and recorded.
12. The measurement shall be repeated at the lowest and the highest channel of the stated frequency range.

12.4 Test Equipment Used

Description	Manufacturer	Model No.	Serial No.	Last Cal.	Cal. Interval
Spectrum Analyzer	ROHDE& SCHWARZ	FSEA20	DE25181	2019-01-02	1 Year
Spectrum Analyzer	Agilent	E4407B	MY4951005	2019-01-02	1 Year
EMI Receiver	ROHDE& SCHWARZ	ESCI	101165	2019-01-02	1 Year
Bilog Antenna	SCHWARZBE CK	VULB9168	9120-426	2019-01-02	1 Year
Horn Antenna	SCHWARZBE CK	BBHA9120D	SW060023	2019-01-02	1 Year
Horn Antenna	SCHWARZBE CK	BBHA9120	BBHA9170 D	2019-01-02	1 Year
Active Loop Antenna	Beijing Daze	ZN30900A	SEL0097	2019-01-02	1 Year
Pre-amplifier	SCHWARZBE CK	BBV9743	9743-019	2019-01-02	1 Year
Pre-amplifier	Quietek	AP-180C	CHM-060212	2019-01-02	1 Year
Signal Generator	ROHDE& SCHWARZ	SML03	T0054	2019-01-02	1 Year
Temp. & Humid. Chamber	GIANT	IHT-550	IKW682-05	2019-01-02	1 Year

12.5 Test Date

(2) Bellow 1 G

EUT:	Bluetooth Speaker	Model Name :	DSBT048
Temperature:	23°C	Relative Humidity:	60%
Pressure:	1010 hPa	Test Voltage :	DC3.7V
Test Mode :	RX 2402MHz		

Frequency (MHz)	Ant H / V	TX/RX	Measured (dBm)	Limits (dBm)	Margins	Note
30.0000	V	TX	-68.38	-57.00	11.38	
92.0500	V	TX	-72.65	-57.00	15.65	
185.6100	V	TX	-68.53	-57.00	11.53	
409.0500	V	TX	-72.67	-57.00	15.67	
595.6700	V	TX	-65.99	-57.00	8.99	

57.3100	H	TX	-70.74	-57.00	13.74	
185.6100	H	TX	-68.87	-57.00	11.87	
409.1500	H	TX	-68.47	-57.00	11.47	
500.5200	H	TX	-67.45	-57.00	10.45	
747.3900	H	TX	-64.67	-57.00	7.67	

(2) Above 1 G

EUT:	Bluetooth Speaker	Model Name :	DSBT048
Temperature:	23°C	Relative Humidity:	60%
Pressure:	1010 hPa	Test Voltage :	DC3.7V
Test Mode :	RX 2402MHz 1Mbps		

Frequency (MHz)	Ant H / V	TX/RX	Measured (dBm)	Limits (dBm)	Margins	Note
1602.3100	V	RX	-62.39	-47.00	15.39	
---	V	RX	---		---	
---	V	RX	---		---	
---	V	RX	---		---	

1602.3100	H	RX	-54.77	-30.00	7.77	
---	H	RX	---		---	
---	H	RX	---		---	

EUT:	Bluetooth Speaker	Model Name :	DSBT048
Temperature:	23°C	Relative Humidity:	60%
Pressure:	1010 hPa	Test Voltage :	DC3.7V
Test Mode :	RX 2480 MHz 1Mbps		

Frequency (MHz)	Ant H / V	TX/RX	Measured (dBm)	Limits (dBm)	Margins	Note
1653.2100	V	RX	-60.64	-36.00	13.64	
---	V	RX	---	-36.00	---	
---	V	RX	---	-36.00	---	

1653.2100	H	RX	-55.37	-36.00	8.37	
---	H	RX	---	-36.00	---	
---	H	RX	---	-36.00	---	

EUT:	Bluetooth Speaker	Model Name :	DSBT048
Temperature:	23°C	Relative Humidity:	60%
Pressure:	1010 hPa	Test Voltage :	DC3.7V
Test Mode :	RX 2402MHz 3 Mbps		

Frequency (MHz)	Ant H / V	TX/RX	Measured (dBm)	Limits (dBm)	Margins	Note
1602.3600	V	RX	-63.37	-36.00	16.37	
---	V	RX	---	-36.00	---	
---	V	RX	---	-36.00	---	

1602.3600	H	RX	-55.07	-36.00	8.07	
---	H	RX	---	-36.00	---	
---	H	RX	---	-36.00	---	

EUT:	Bluetooth Speaker	Model Name :	DSBT048
Temperature:	23°C	Relative Humidity:	60%
Pressure:	1010 hPa	Test Voltage :	DC3.7V
Test Mode :	RX 2480MHz 3 Mbps		

Frequency (MHz)	Ant H / V	TX/RX	Measured (dBm)	Limits (dBm)	Margins	Note
1653.0100	V	RX	-64.61	-36.00	17.61	
---	V	RX	---	-36.00	---	
---	V	RX	---	-36.00	---	

1623.0300	H	RX	-57.00	-36.00	10.00	
---	H	RX	---	-36.00	---	
---	H	RX	---	-36.00	---	

13 Receiver Blocking

13.1 Test Standard and Limit

13.1.1 Test Standard

ETSI EN 300 328 V2.1.1: 2016 clause 4.3.1.11

13.1.2 Test Description

Receiver blocking is a measure of the capability of the adaptivity mechanism to operate as intended (see clause 4.3.1.6) in the presence of an unwanted signal (blocking signal) on frequencies other than those of the operating channel and the adjacent channels.

Adaptive Frequency Hopping equipment is allowed to have Short Control Signaling Transmissions (e.g. ACK/NACK signals, etc.) without sensing the frequency for the presence of other signals. Please see clause 4.3.1.6.3 Short Control Signaling Transmissions

13.1.3 Test Limits

Adaptive Frequency Hopping equipment shall comply with the requirements defined in clauses 4.3.1.6.1 (LBT based DAA) or 4.3.1.6.2 (non-LBT based AA) in the presence of a blocking signal with characteristics as provided in below:

d)

13.2 Test Setup

This requirement does not apply to non-adaptive equipment or adaptive equipment operating in a non-adaptive mode providing the equipment complies with the requirements and /or restrictions applicable to non-adaptive equipment.

In addition, this requirement does not apply for equipment with a maximum declared RF Output power level of less than 10 dBm e.i.r.p. for equipment when operating in a mode where the RF Output power is less than 10 dBm e.i.r.p.

Note:

The Equipment e.i.r.p. power is less than 10 dBm, so no requirement for this test item.

14 Photographs - Constructional Details

Photo 1 Appearance of EUT

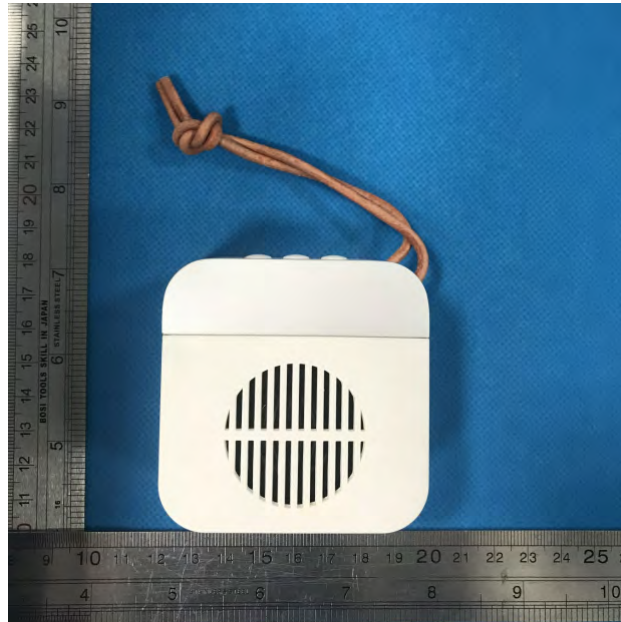

Photo 2 Appearance of EUT



Photo 3 Appearance of EUT

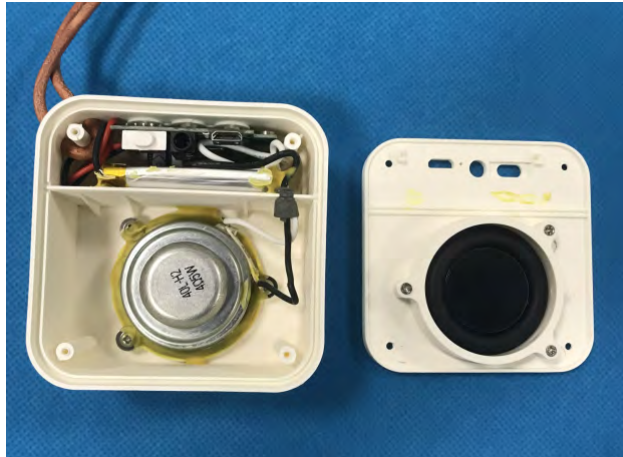

Photo 4 Appearance of EUT



END OF REPORT